

LOCKSETS

Price List 2017

CAL-ROYAL
P R O D U C T S , I N C . U . S . A .



TABLE OF CONTENTS

I. GRADE 1

MORTISE

ESCUTCHEON

NM Series.....	L5-L10
WI Series (NM Series).....	L11-L13
WI Series (SC Series).....	L18-L19

SECTIONAL

NM Series.....	L1-L4
SC Series.....	L16-L17

DEADBOLT

NM Series.....	L14
SC Series.....	L20

ACCESSORIES

NM Series.....	L15
SC Series.....	L21

HOSPITAL

HL Series.....	L23
----------------	-----

ANTI - LIGATURE

LG Series.....	L24
----------------	-----

TUBULAR

HOSPP Series.....	L26
-------------------	-----

CYLINDRICAL

Genesys Series.....	L28
Calypso Series.....	L36
Omega GRB Series.....	L38

DEADBOLTS

CRB800 Series.....	L67
--------------------	-----

II. GRADE 2

MECHANICAL

CRCODE200 Series.....	L44
-----------------------	-----

CYLINDRICAL

Pioneer SL & CSL Series.....	L45
Commander Com (Clutch).....	L49
Explorer XP & CXP Series.....	L50
Challenger Series.....	L54
Tuscany Series.....	L42
Barrington BA Series.....	L58

INTERCONNECTED

HIL Series List.....	L62
JHIL Series.....	L63

DEADBOLT

T300 Series.....	L69
T400 Series.....	L71
CB160 Series.....	L73
Standard Duty Deadbolts Series.....	L75
Gate Latch Dead Latches Series.....	L77

III. GRADE 3

CYLINDRICAL

Columbus Series.....	L61
Epic Series.....	L64

III. GRADE 3

DEADBOLT

LSD Series.....	L79
IND84 Indicator Deadbolts Series.....	L80
Chelsie Series.....	L88

TUBULAR

Legacy Series.....	L98
Clipper Series.....	L99
Contemporary Series.....	L85
Summit Series.....	L86
Chelsie Series.....	L83
Vanguard Series.....	L91
Heritage Series.....	L97
Ashley Series.....	L81
Italia Series.....	L92

HANDLESETS

Chelsie Series.....	L87
---------------------	-----

IV. KEYS & KEYING

REPLACEMENT CYLINDERS

Key-in-Knob-Lever Cylinders.....	L102
Rim Cylinders.....	L103
Mortise Cylinders.....	L102
Mortise and Rim Cylinders.....	L104
Mortise Cylinder Accessories.....	L103
Mortise Cylinder Cams.....	L103
Small Format IC Cylinders.....	L105
Large Format IC Cylinders.....	L106

RESTRICTED CYLINDERS

Key-in-Knob-Lever Cylinders.....	L107
Small Format IC Cylinders.....	L107
Mortise Cylinders.....	L107
Single Cylinder Deadbolt Kits.....	L107
Double Cylinder Deadbolt Kits.....	L107
Mortise and Rim Cylinder Kits.....	L107
.....	L107

HIGH SECURITY KEY (HSK) SYSTEM

Key-in-Knob-Lever Cylinders.....	L108
Mortise-Rim Combo Cylinder.....	L108
Small Format Interchangeable Core Cylinders.....	L108
Large Format Interchangeable Core Cylinders.....	L108
IC Housing.....	L108
Accessories.....	L109

CRP COMBI CYLINDER PROGRAM

Key-in-Knob-Lever Cylinders.....	L113
Small Format IC Cylinders.....	L113
Mortise Cylinders.....	L113
Large Format Interchangeable Cores.....	L113
European Profile Cylinders.....	L113
CRP Combi Pinning Kits.....	L114

COMMERCIAL KEYING CHARGES.....

RESIDENTIAL KEYING CHARGES.....

NM Series *List Price*

HEAVY DUTY, GRADE 1 MORTISE LOCKSET List Price

Optional Interchangeable Core Small Format (Best, Falcon and Arrow) or Large Format (Schlage)

3 HOUR FIRE RATED UL10C, UBC7-2-1997	LIFETIME WARRANTY	BHMA CERTIFIED Be Safe. Be Secure. Look for the Mark.	MEETS <i>The Buy American Act</i>	HURRICANE APPROVED HARDWARE FLORIDA BUILDING CODE: FL13922-R1 ASTM E1886/E1996 ASTM E330 TAS 201, 202, 203 UL10B UL19C
--------------------------------------	--------------------------	---	---	--

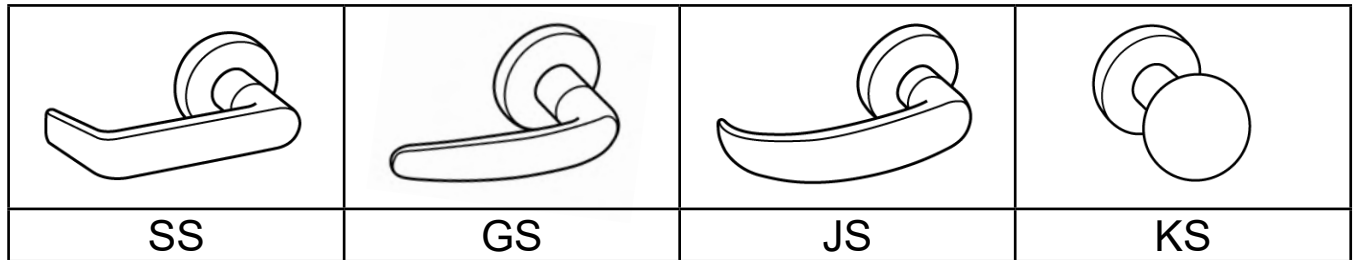

ALL ITEMS BELOW AVAILABLE WITH FACTORY LEAD TIME AND SUBJECT TO MINIMUM ORDER QUANTITY

SS, GS, JS, AND KS SECTIONAL TRIM ONLY								
FUNCTIONS	ANSI	FINISHES						
		US26D	US32D	US32	US10B	US3	US26	US4
◀Single cylinder without deadbolt								
NM8050 - Office / Entrance	F04	\$501.30	\$591.70	\$591.71	\$525.04	\$525.04	\$525.04	\$525.04
NM8070 - Classroom	F05							
NM8080 - Storeroom	F07							
◀Single cylinder with deadbolt								
NM8453 - Entrance	F20	517.16	635.91	635.91	540.91	540.91	540.91	540.91
NM8456 - Corridor	F13							
NM8495 - Keyed Privacy w/ Indicator	----	683.30	802.05	802.05	707.05	707.05	707.05	707.05
NM8465 - Closet / Storeroom	----	517.16	635.91	635.91	540.91	540.91	540.91	540.91
NM8473 - Dormitory / Bedroom	F21							
◀Double cylinder without deadbolt								
NM8060 - Apartment Entrance	F09	559.33	678.08	678.08	583.08	583.08	583.08	583.08
NM8082 - Institution	F30	559.33						
◀ Double cylinder with deadbolt								
NM8466 - Storeroom	F14	559.33						
◀Other Functions								
NM8040 - Privacy with Deadbolt	F02,F19,F22	448.57	567.21	472.32	472.32	472.32	472.32	472.32
NM8445 - Privacy with Indicator	----	617.71	733.35	638.46	638.46	638.46	638.46	638.46
NM8010 - Passage	F01	395.75	514.50	514.50	419.50	419.50	419.50	419.50
NM8170 - Single Fixed Dummy	----	131.95	250.70	250.70	155.70	155.70	155.70	155.70
NM8172 - Double Fixed Dummy	----	276.90	345.59	345.59	329.50	329.50	329.50	329.50

Optional Interchangeable Cores (See page L15 for additional charges). Prices do not include cores. For IC Core pricing see pages L105 – L106. For Keying charges see page L115.

HEAVY DUTY, GRADE 1 MORTISE LOCKSET List Price

Optional Interchangeable Core Small Format (Best, Falcon and Arrow) or Large Format (Schlage)

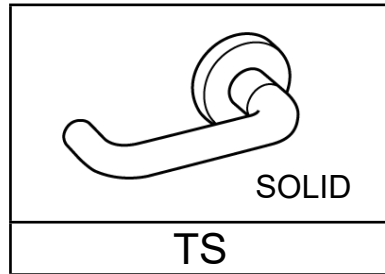
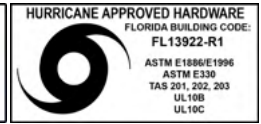

STOCK ITEM PRICES IN BOLD. (FOR OTHER DESIGNS, SEE NEXT PAGE)
NON-STOCK FINISHES AVAILABLE WITH FACTORY LEAD TIME AND SUBJECT TO MINIMUM ORDER

TS SECTIONAL TRIM ONLY								
FUNCTIONS	ANSI	FINISHES						
		US26D	US32D	US32	US10B	US3	US26	US4
◀ Single cylinder without deadbolt								
NM8050 - Office / Entrance	F04							
NM8070 - Classroom	F05	\$501.29	\$591.71	\$591.71	\$525.04	\$525.04	\$525.04	\$525.04
NM8080 - Storeroom	F07							
◀ Single cylinder with deadbolt								
NM8453 - Entrance	F20	517.16	635.91	635.91	540.90	540.90	540.90	540.90
NM8456 - Corridor	F13							
NM8495 - Keyed Privacy w/ Indicator	----	683.30	802.05	802.05	707.05	707.05	707.05	707.05
NM8465 - Closet / Storeroom	----	517.16	635.91	635.91	540.90	540.90	540.90	540.90
NM8473 - Dormitory / Bedroom	F21							
◀ Double cylinder without deadbolt								
NM8060 - Apartment Entrance	F09	559.35						
NM8082 - Institution	F30	559.35	678.08	678.08	583.08	583.08	583.08	583.08
◀ Double cylinder with deadbolt								
NM8466 - Storeroom	F14	559.35						
◀ Other Functions								
NM8040 - Privacy with Deadbolt	F02,F19,F22	448.57	567.21	472.35	472.35	472.35	472.35	472.35
NM8445 - Privacy with Indicator	----	614.70	733.35	638.45	638.45	638.45	638.45	638.45
NM8010 - Passage	F01	395.75	514.50	514.50	419.50	419.50	419.50	419.50
NM8170 - Single Fixed Dummy	----	131.95	250.70	250.70	155.70	155.70	155.70	155.70
NM8172 - Double Fixed Dummy	----	276.90	345.60	345.60	329.50	329.50	329.50	329.50

◀ All keyed lock functions are available with Best, Falcon and Arrow, Schlage, Corbin / Russwin, Sargent, and Yale Large Format Interchangeable Cores (See page L15 for additional charges). Prices do not include cores. For IC Core pricing see pages L105 – L106. For Keying charges see page L115.

HEAVY DUTY, GRADE 1 MORTISE LOCKSET List Price

Optional Interchangeable Core Small Format (Best, Falcon and Arrow) or Large Format (Schlage)







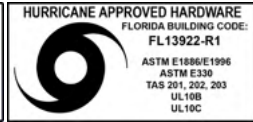

LIFETIME WARRANTY

BHMA CERTIFIED
 Be Safe. Be Secure. Look for the Mark.

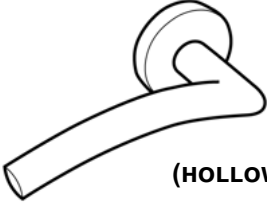
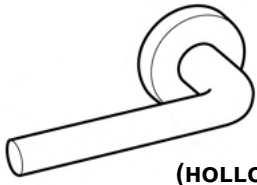
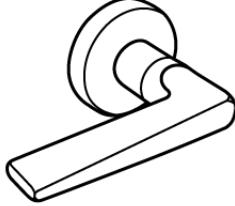
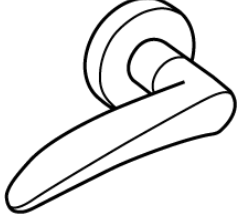
MEETS
The Buy American Act

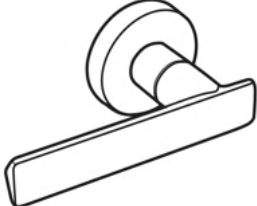

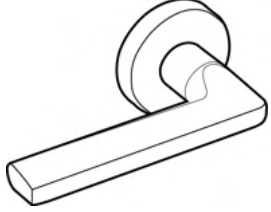
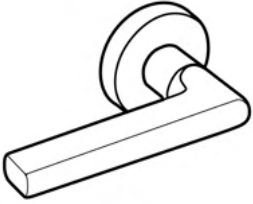
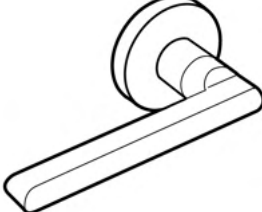
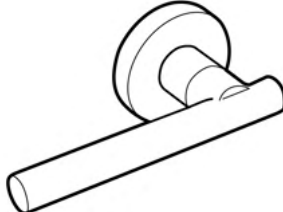
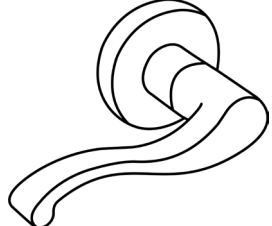
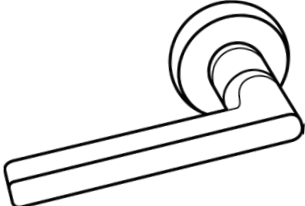
SECTIONAL TRIMS

 (HOLLOW) CS	 (HOLLOW) HS	 VS	 YS
 FS	 IS	 DS	 MS
 QS	 ZS	 RS	 PS
 WS	 XS		

NM Series *List Price*



LIFETIME WARRANTY



MEETS
The Buy American Act



NON-STOCK ITEMS
ALL ITEMS BELOW AVAILABLE WITH FACTORY LEAD TIME AND SUBJECT TO MINIMUM ORDER QUANTITY

CS, HS, VS, YS, DS, FS, IS, MS, QS, RS, PS, WS, XS, ZS SECTIONAL TRIM ONLY

FUNCTIONS	ANSI	FINISHES						
		US26D	US32D	US32	US10B	US3	US26	US4
◀Single cylinder without deadbolt								
NM8050 - Office / Entrance	F04							
NM8070 - Classroom	F05	\$501.29	\$591.70	\$591.70	\$525.04	\$525.04	\$525.04	\$525.04
NM8080 - Storeroom	F07							
◀Single cylinder with deadbolt								
NM8453 - Entrance	F20							
NM8456 - Corridor	F13	517.15	635.90	635.90	540.90	540.90	540.90	540.90
NM8495 - Keyed Privacy w/ Indicator	----	683.30	803.05	707.05	707.05	707.05	707.05	707.05
NM8465 - Closet / Storeroom	----							
NM8473 - Dormitory / Bedroom	F21	517.15	635.90	635.90	540.90	540.90	540.90	540.90
◀Double cylinder without deadbolt								
NM8060 - Apartment Entrance	F09							
NM8082 - Institution	F30	559.30	678.10	678.10	583.10	583.10	583.10	583.10
◀Double cylinder with deadbolt								
NM8466 - Storeroom	F14							
◀Other Functions								
NM8040 - Privacy with Deadbolt	F02,F19,F22	448.57	566.60	566.60	472.00	472.00	472.00	472.00
NM8445 - Privacy with Indicator	----	615.00	733.00	733.00	638.50	638.50	638.50	638.50
NM8010 - Passage	F01	395.75	514.50	514.50	419.50	419.50	419.50	419.50
NM8170 - Single Fixed Dummy	----	132.00	250.70	250.70	155.70	155.70	155.70	155.70
NM8172 - Double Fixed Dummy	----	276.90	345.60	345.60	330.00	330.00	330.00	330.00

••• All keyed lock functions are available with **Best, Falcon and Arrow, Schlage, Corbin / Russwin, Sargent, and Yale Large Format Interchangeable Cores** (See page L15 for additional charges). Prices do not include cores. For IC Core pricing see pages L105 – L106. For Keying charges see page L115.

HEAVY DUTY, GRADE 1 MORTISE LOCKSET List Price

Optional Interchangeable Core Small Format (Best, Falcon and Arrow) or Large Format (Schlage)

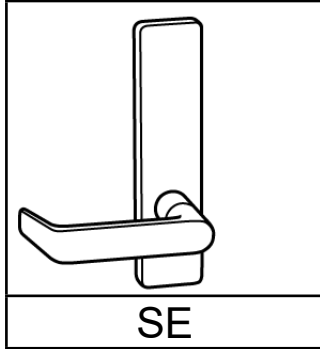

STOCK ITEM PRICES IN BOLD. (FOR OTHER DESIGNS, SEE NEXT PAGE)

NON-STOCK FINISHES AVAILABLE WITH FACTORY LEAD TIME AND SUBJECT TO MINIMUM ORDER

SE ESCUTCHEON TRIM ONLY							
FUNCTIONS	ANSI	FINISHES					
		US26D	US32D	US10B	US3	US26	US4
◀ Single cylinder without deadbolt							
NM8050 - Office / Entrance	F04						
NM8070 - Classroom	F05	\$546.00	\$665.00	\$570.00	\$570.00	\$570.00	\$570.00
NM8080 - Storeroom	F07						
◀ Single cylinder with deadbolt							
NM8453 - Entrance	F20			583.00	583.00	583.00	
NM8456 - Corridor	F13	560.00	678.00	583.00	583.00	583.00	583.00
NM8495 - Keyed Privacy w/ Indicator	----	725.50	844.00	599.00	599.00	599.00	599.00
NM8465 - Closet / Storeroom	----	560.00	678.00	583.00	583.00	583.00	583.00
NM8473 - Dormitory / Bedroom	F21						
◀ Double cylinder without deadbolt							
NM8060 - Apartment Entrance	F09	588.00					
NM8082 - Institution	F30	588.00	707.10	612.00	612.00	612.00	612.00
◀ Double cylinder with deadbolt							
NM8466 - Storeroom	F14	588.00					
◀ Other Functions							
NM8040 - Privacy with Deadbolt	F02,F19,F22	523.00	642.00	546.00	546.00	546.00	546.00
NM8445 - Privacy with Indicator	----	688.50	807.00	712.00	712.00	712.00	712.00
NM8010 - Passage	F01	454.00	572.50	477.50	477.50	477.50	477.50
NM8170 - Single Fixed Dummy	----	147.80	266.50	171.50	171.50	171.50	171.50
NM8172 - Double Fixed Dummy	----	325.70	395.00	387.00	387.00	387.00	387.00

Optional Interchangeable Cores (See page L15 for additional charges). Prices do not include cores. For IC Core pricing see pages L105 – L106. For Keying charges see page L115.

HEAVY DUTY, GRADE 1 MORTISE LOCKSET List Price

Optional Interchangeable Core Small Format (Best, Falcon and Arrow) or Large Format (Schlage)

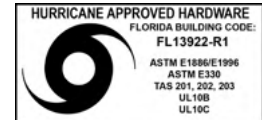
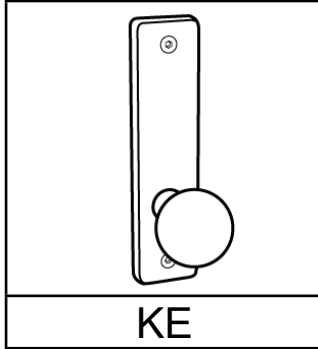

STOCK ITEM PRICES IN BOLD. (FOR OTHER DESIGNS, SEE NEXT PAGE)

NON-STOCK FINISHES AVAILABLE WITH FACTORY LEAD TIME AND SUBJECT TO MINIMUM ORDER

KE ESCUTCHEON TRIM ONLY							
FUNCTIONS	ANSI	FINISHES					
		US26D	US32D	US10B	US3	US26	US4
◀ Single cylinder without deadbolt							
NM8050 - Office / Entrance	F04	\$546.00	\$665.00	\$570.00	\$570.00	\$570.00	\$570.00
NM8070 - Classroom	F05						
NM8080 - Storeroom	F07						
◀ Single cylinder with deadbolt							
NM8453 - Entrance	F20	560.00	678.00	583.00	583.00	583.00	583.00
NM8456 - Corridor	F13						
NM8495 - Keyed Privacy w/ Indicator	----	725.00	844.00	599.00	599.00	599.00	599.00
NM8465 - Closet / Storeroom	----	560.00	678.00	583.00	583.00	583.00	583.00
NM8473 - Dormitory / Bedroom	F21						
◀ Double cylinder without deadbolt							
NM8060 - Apartment Entrance	F09	588.00	707.10	612.00	612.00	612.00	612.00
NM8082 - Institution	F30	588.00					
◀ Double cylinder with deadbolt							
NM8466 - Storeroom	F14	588.00					
◀ Other Functions							
NM8040 - Privacy with Deadbolt	F02,F19,F22	523.00	641.00	546.00	546.00	546.00	546.00
NM8445 - Privacy with Indicator	----	688.00	807.00	712.00	712.00	712.00	712.00
NM8010 - Passage	F01	454.00	573.00	477.00	477.00	477.00	477.00
NM8170 - Single Fixed Dummy	----	147.80	266.00	266.00	171.00	171.00	171.00
NM8172 - Double Fixed Dummy	----	326.00	394.00	388.00	388.00	388.00	388.00

Optional Interchangeable Cores (See page L15 for additional charges). Prices do not include cores. For IC Core pricing see pages L105 – L106. For Keying charges see page L115.

HEAVY DUTY, GRADE 1 MORTISE LOCKSET List Price

Optional Interchangeable Core Small Format (Best, Falcon and Arrow) or Large Format (Schlage)

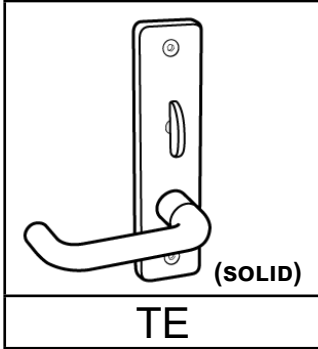

STOCK ITEM PRICES IN BOLD. (FOR OTHER DESIGNS, SEE NEXT PAGE)

NON-STOCK FINISHES AVAILABLE WITH FACTORY LEAD TIME AND SUBJECT TO MINIMUM ORDER

TE ESCUTCHEON TRIM ONLY							
FUNCTIONS	ANSI	FINISHES					
		US26D	US32D	US10B	US3	US26	US4
◀ Single cylinder without deadbolt							
NM8050 - Office / Entrance	F04						
NM8070 - Classroom	F05	\$546.00	\$665.00	\$570.00	\$570.00	\$570.00	\$570.00
NM8080 - Storeroom	F07						
◀ Single cylinder with deadbolt							
NM8453 - Entrance	F20						
NM8456 - Corridor	F13	560.00	678.00	583.00	583.00	583.00	583.00
NM8495 - Keyed Privacy w/ Indicator	----	725.00	844.00	599.00	599.00	599.00	599.00
NM8465 - Closet / Storeroom	----	560.00	678.00	583.00	583.00	583.00	583.00
NM8473 - Dormitory / Bedroom	F21						
◀ Double cylinder without deadbolt							
NM8060 - Apartment Entrance	F09	588.00					
NM8082 - Institution	F30	588.00					
			707.10	612.00	612.00	612.00	612.00
◀ Double cylinder with deadbolt							
NM8466 - Storeroom	F14	588.00					
◀ Other Functions							
NM8040 - Privacy with Deadbolt	F02,F19,F22	523.00	641.00	546.00	546.00	546.00	546.00
NM8445 - Privacy with Indicator	----	688.00	807.00	712.00	712.00	712.00	712.00
NM8010 - Passage	F01	454.00	573.00	477.00	477.00	477.00	477.00
NM8170 - Single Fixed Dummy	----	147.80	266.00	266.00	171.00	171.00	171.00
NM8172 - Double Fixed Dummy	----	326.00	394.00	388.00	388.00	388.00	388.00

Optional Interchangeable Cores (See page L15 for additional charges). Prices do not include cores. For IC Core pricing see pages L105 – L106. For Keying charges see page L115.

HEAVY DUTY, GRADE 1 MORTISE LOCKSET List Price

Optional Interchangeable Core Small Format (Best, Falcon and Arrow) or Large Format (Schlage)



LIFETIME WARRANTY

BHMA CERTIFIED
Be Safe. Be Secure. Look for the Mark.

MEETS
The Buy American Act

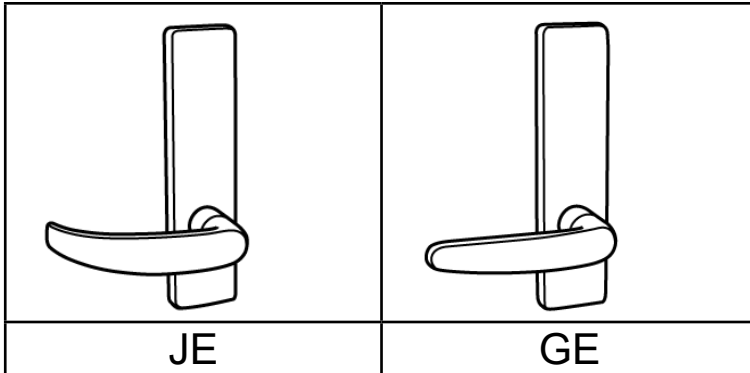
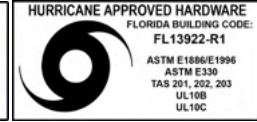

STOCK ITEM PRICES IN BOLD. (FOR OTHER DESIGNS, SEE NEXT PAGE)
NON-STOCK FINISHES AVAILABLE WITH FACTORY LEAD TIME AND SUBJECT TO MINIMUM ORDER

JE AND GE ESCUTCHEON TRIM ONLY							
FUNCTIONS	ANSI	FINISHES					
		US26D	US32D	US10B	US3	US26	US4
◀ Single cylinder without deadbolt							
NM8050 - Office / Entrance	F04	\$546.00	\$664.00	\$570.00	\$570.00	\$570.00	\$570.00
NM8070 - Classroom	F05						
NM8080 - Storeroom	F07						
◀ Single cylinder with deadbolt							
NM8453 - Entrance	F20	560.00	678.00	583.00	583.00	583.00	583.00
NM8456 - Corridor	F13						
NM8495 - Keyed Privacy w/ Indicator	----	725.00	844.00	599.00	599.00	599.00	599.00
NM8465 - Closet / Storeroom	----	560.00	678.00	583.00	583.00	583.00	583.00
NM8473 - Dormitory / Bedroom	F21						
◀ Double cylinder without deadbolt							
NM8060 - Apartment Entrance	F09	588.00	707.10	612.00	612.00	612.00	612.00
NM8082 - Institution	F30	588.00					
◀ Double cylinder with deadbolt							
NM8466 - Storeroom	F14	588.00					
◀ Other Functions							
NM8040 - Privacy with Deadbolt	F02,F19,F22	523.00	641.00	546.00	546.00	546.00	546.00
NM8445 - Privacy with Indicator	----	688.00	807.00	712.00	712.00	712.00	712.00
NM8010 - Passage	F01	454.00	573.00	477.00	477.00	477.00	477.00
NM8170 - Single Fixed Dummy	----	147.80	266.00	266.00	171.00	171.00	171.00
NM8172 - Double Fixed Dummy	----	326.00	394.00	388.00	388.00	388.00	388.00

◀ All keyed lock functions are available with Best, Falcon and Arrow, Schlage, Corbin / Russwin, Sargent, and Yale Large Format Interchangeable Cores (See page L15 for additional charges). Prices do not include cores. For IC Core pricing see pages L105 – L106. For Keying charges see page L115.

NM Series *List Price*

HEAVY DUTY, GRADE 1 MORTISE LOCKSET List Price



Optional Interchangeable Core Small Format (Best, Falcon and Arrow) or Large Format (Schlage)

LIFETIME WARRANTY

BHMA CERTIFIED
Be Safe. Be Secure. Look for the Mark.

MEETS
The Buy American Act

ESCUTCHEON TRIMS

(HOLLOW) CE	(HOLLOW) HE	 VE	 YE
 FE	 IE	 DE	 ME
 QE	 ZE	 RE	 PE
 WE	 XE		

HEAVY DUTY, GRADE 1 MORTISE LOCKSET List Price
Optional Interchangeable Core Small Format (Best, Falcon and Arrow)
or Large Format (Schlage)



LIFETIME WARRANTY



MEETS
The Buy American Act

NON STOCK ITEMS

ALL ITEMS BELOW AVAILABLE WITH FACTORY LEAD TIME AND SUBJECT TO MINIMUM ORDER QUANTITY

**CE, HE, VE, YE, FE, IE, DE, ME, QE, ZE, RE, PE, WE, XE
ESCUTCHEON TRIM ONLY**

FUNCTIONS	ANSI	FINISHES					
		US26D	US32D	US10B	US3	US26	US4
◀Single cylinder without deadbolt							
NM8050 - Office / Entrance	F04						
NM8070 - Classroom	F05	\$546.00	\$665.00	\$570.00	\$570.00	\$570.00	\$570.00
NM8080 - Storeroom	F07						
◀Single cylinder with deadbolt							
NM8453 - Entrance	F20						
NM8456 - Corridor	F13	560.00	678.00	583.00	583.00	583.00	583.00
NM8495 - Keyed Privacy w/ Indicator	----	725.00	844.00	599.00	599.00	599.00	599.00
NM8465 - Closet / Storeroom	----						
NM8473 - Dormitory / Bedroom	F21	560.00	678.00	583.00	583.00	583.00	583.00
◀Double cylinder without deadbolt							
NM8060 - Apartment Entrance	F09	588.00					
NM8082 - Institution	F30	588.00					
			707.10	612.00	612.00	612.00	612.00
◀Double cylinder with deadbolt							
NM8466 - Storeroom	F14	588.00					
◀Other Functions							
NM8040 - Privacy with Deadbolt	F02,F19,F22	523.00	641.00	546.00	546.00	546.00	546.00
NM8445 - Privacy with Indicator	----	688.00	807.00	712.00	712.00	712.00	712.00
NM8010 - Passage	F01	454.00	573.00	477.00	477.00	477.00	477.00
NM8170 - Single Fixed Dummy	----	147.80	266.00	171.00	171.00	171.00	171.00
NM8172 - Double Fixed Dummy	----	326.00	394.00	388.00	388.00	388.00	388.00

◉ All keyed lock functions are available with Best, Falcon and Arrow, Schlage, Corbin / Russwin, Sargent, and Yale Large Format Interchangeable Cores (See page L15 for additional charges). Prices do not include cores. For IC Core pricing see pages L105 - L106. For Keying charges see page L115.

WI Series *List Price*

HEAVY DUTY, GRADE 1 WIDE ESCUTCHEON MORTISE LOCKSET

Optional Interchangeable Core Small Format (Best, Falcon and Arrow) or Large Format (Schlage)

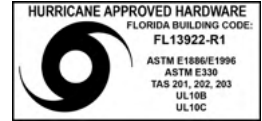

LIFETIME WARRANTY

BHMA™ CERTIFIED
Be Safe. Be Secure. Look for the Mark.

MEETS
The Buy American Act

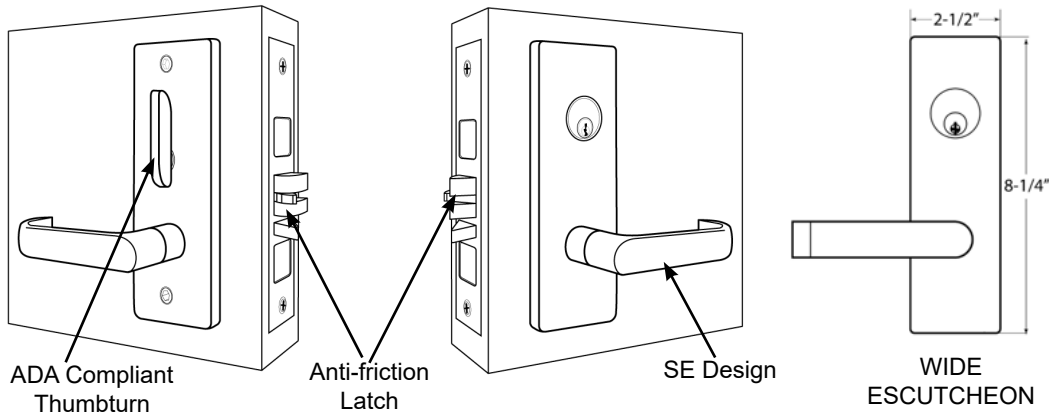

STOCK ITEM PRICES IN BOLD. (FOR OTHER DESIGNS, SEE NEXT PAGE)

NON-STOCK FINISHES AVAILABLE WITH FACTORY LEAD TIME AND SUBJECT TO MINIMUM ORDER

WIDE ESCUTCHEON SE TRIM ONLY

FUNCTIONS	ANSI	FINISHES				
		US26D	US10B	US3	US26	US4
◀ Single cylinder without deadbolt						
WI8050 - Office / Entrance	F04					
WI8070 - Classroom	F05	\$692.00	\$692.00	\$692.00	\$692.00	\$692.00
WI8080 - Storeroom	F07					
◀ Single cylinder with deadbolt						
WI8453 - Entrance	F20	704.50	704.50	704.50	704.50	704.50
WI8456 - Corridor	F13					
WI8495 - Keyed Privacy w/ Indicator	----	870.50	870.50	870.50	870.50	870.50
WI8465 - Closet / Storeroom	----	704.50	704.50	704.50	704.50	704.50
WI8473 - Dormitory / Bedroom	F21					
◀ Double cylinder without deadbolt						
WI8060 - Apartment Entrance	F09	737.00				
WI8082 - Institution	F30	737.00				
			737.00	737.00	737.00	737.00
◀ Double cylinder with deadbolt						
WI8466 - Storeroom	F14	737.00				
◀ Other Functions						
WI8040 - Privacy with Deadbolt	F02,F19,F22	667.00	667.00	667.00	667.00	667.00
WI8445 - Privacy with Indicator	----	833.00	833.00	833.00	833.00	833.00
WI8010 - Passage	F01	591.00	591.00	591.00	591.00	591.00
WI8170 - Single Fixed Dummy	----	261.50	261.50	261.50	261.50	261.50

Optional Interchangeable Cores (See page L15 for additional charges). Prices do not include cores. For IC Core pricing see pages L105 - L106. For Keying charges see page L115.

WI Series *List Price*

HEAVY DUTY, GRADE 1 WIDE ESCUTCHEON MORTISE LOCKSET

Optional Interchangeable Core Small Format (Best, Falcon and Arrow) or Large Format (Schlage)

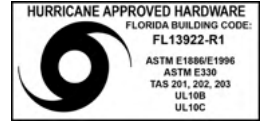

 <small>3 HOUR FIRE RATED UL10C, UBC7-2-1997</small>	LIFETIME WARRANTY	BHMA CERTIFIED <small>Be Safe. Be Secure. Look for the Mark.</small>	MEETS <i>The Buy American Act</i>
---	--------------------------	--	---

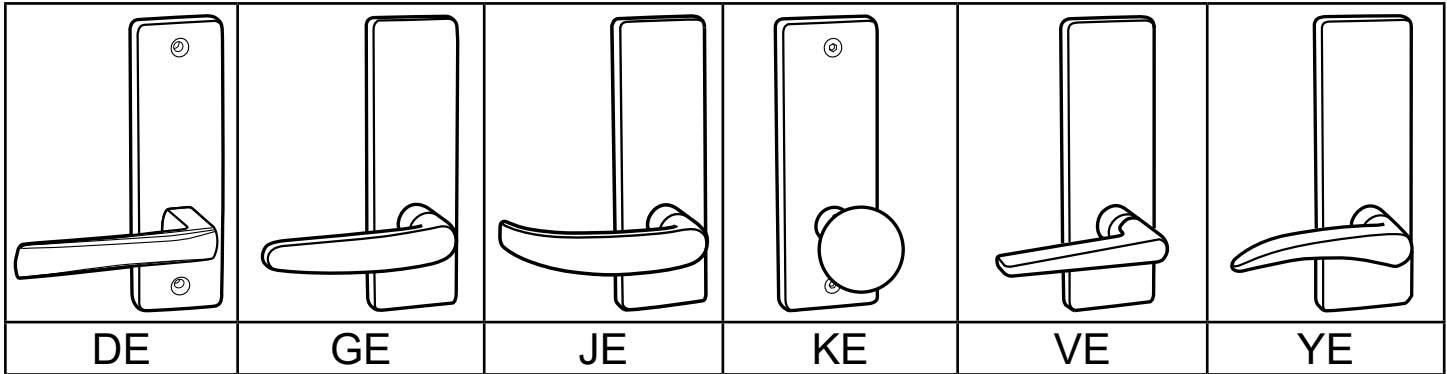

ALL ITEMS BELOW AVAILABLE WITH FACTORY LEAD TIME AND SUBJECT TO MINIMUM ORDER QUANTITY

WIDE ESCUTCHEON CE, DE, GE, HE, JE, KE, TE, VE, YE TRIM ONLY

FUNCTIONS	ANSI	FINISHES				
		US26D	US32D	US32	US10B	US3
◀ Single cylinder without deadbolt						
WI8050 - Office / Entrance	F04	\$692.00	\$692.00	\$692.00	\$692.00	\$692.00
WI8070 - Classroom	F05					
WI8080 - Storeroom	F07					
◀ Single cylinder with deadbolt						
WI8453 - Entrance	F20	704.50	704.50	704.50	704.50	704.50
WI8456 - Corridor	F13					
WI8495 - Keyed Privacy w/ Indicator	----	870.50	870.50	870.50	870.50	870.50
WI8465 - Closet / Storeroom	----	704.50	704.50	704.50	704.50	704.50
WI8473 - Dormitory / Bedroom	F21					
◀ Double cylinder without deadbolt						
WI8060 - Apartment Entrance	F09	737.00	737.00	737.00	737.00	737.00
WI8082 - Institution	F30					
◀ Double cylinder with deadbolt						
WI8466 - Storeroom	F14					
◀ Other Functions						
WI8040 - Privacy with Deadbolt	F02,F19,F22	667.00	667.00	667.00	667.00	667.00
WI8445 - Privacy with Indicator	----	833.00	833.00	833.00	833.00	833.00
WI8010 - Passage	F01	591.00	591.00	591.00	591.00	591.00
WI8170 - Single Fixed Dummy	----	261.50	261.50	261.50	261.50	261.50

Optional Interchangeable Cores (See page L15 for additional charges). Prices do not include cores. For IC Core pricing see pages L105 - L106. For Keying charges see page L115.

WI Series *List Price*

HEAVY DUTY, GRADE 1 WIDE ESCUTCHEON MORTISE LOCKSET



Optional Interchangeable Core Small Format (Best, Falcon and Arrow) or Large Format (Schlage)



LIFETIME WARRANTY

BHMA CERTIFIED
Be Safe. Be Secure. Look for the Mark.

MEETS
The Buy American Act

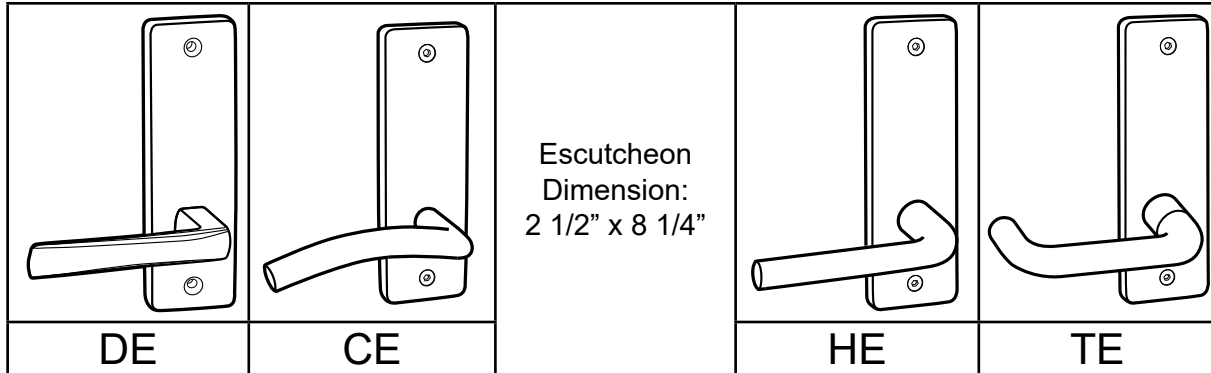

ALL ITEMS BELOW AVAILABLE WITH FACTORY LEAD TIME AND SUBJECT TO MINIMUM ORDER QUANTITY

WIDE ESCUTCHEON WDE, WCE, WHE, WTE TRIM ONLY

FUNCTIONS	ANSI	FINISH
		US32D
◀ Single cylinder without deadbolt		
WI8050 - Office / Entrance	F04	\$844.00
WI8070 - Classroom	F05	
WI8080 - Storeroom	F07	
◀ Single cylinder with deadbolt		
WI8453 - Entrance	F20	861.00
WI8456 - Corridor	F13	
WI8495 - Keyed Privacy w/ Indicator	----	1027.90
WI8465 - Closet / Storeroom	----	861.00
WI8473 - Dormitory / Bedroom	F21	
◀ Double cylinder without deadbolt		
WI8060 - Apartment Entrance	F09	897.00
WI8082 - Institution	F30	
◀ Double cylinder with deadbolt		
WI8466 - Storeroom	F14	
◀ Other Functions		
WI8040 - Privacy with Deadbolt	F02,F19,F22	814.00
WI8445 - Privacy with Indicator	----	980.00
WI8010 - Passage	F01	726.00
WI8170 - Single Fixed Dummy	----	341.00

All keyed lock functions are available with Best, Falcon and Arrow, Schlage, Corbin / Russwin, Sargent, and Yale Large Format Interchangeable Cores (See page L15 for additional charges). Prices do not include cores. For IC Core pricing see pages L105 – L106. For Keying charges see page L115.

M & SM Series *List Price*

HEAVY DUTY, GRADE 1 MORTISE DEADBOLTS

Optional Interchangeable Core Small Format (Best, Falcon and Arrow) or Large Format (Schlage)

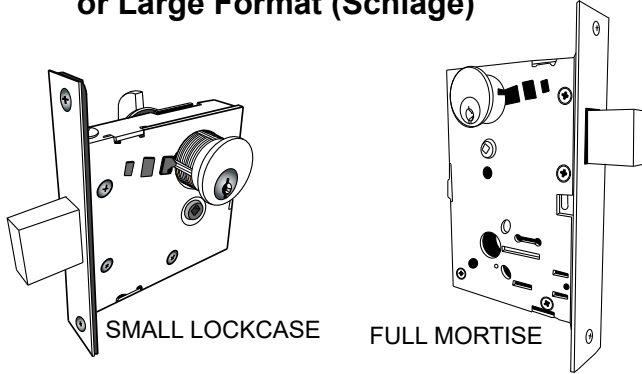

SMALL LOCKCASE

FULL MORTISE



STOCK ITEM PRICES IN BOLD
NON-STOCK FINISHES AVAILABLE WITH FACTORY LEAD TIME AND SUBJECT TO MINIMUM ORDER

MODEL#	ANSI	LIST PRICE EACH		FUNCTIONS	MODEL#	ANSI	LIST PRICE EACH	
		US26D, 32D	US10B, 3, 26, 4				US26D, 32D	US10B, 3, 26, 4
SM4608	E06071	\$192.55	\$211.00	Cylinder and Thumbturn Deadbolt thrown or retracted by key outside or thumbturn inside.	M8460	F17	\$253.00	\$279.00
SM4628	E06061	214.00	234.00	Double Cylinder Deadbolt operated by key on either side.	M8462	F16	270.50	298.00
SM4638	E06091	214.00	234.00	Classroom Lock Deadbolt thrown or retracted by key from outside. Inside cylinder turn retracts deadbolt but cannot project it.	M8463	F29	270.50	298.00
SM4648	E06081	180.00	200.00	Cylinder Lock Deadbolt thrown or retracted by key from one side. No trim on opposite side.	M8464	F18	247.00	272.00
SM4808	---	170.00	187.00	Door Bolt Deadbolt thrown or retracted by thumbturn from one side. No trim on opposite side.	M8480	---	436.65	477.00
SM4968	---	354.00	396.00	Deadbolt with "OCCUPIED" indicator Deadbolt thrown or retracted by key outside or thumbturn inside. "OCC" plate is displayed when deadbolt is thrown.	M8496	---	436.65	477.00

Optional Interchangeable Cores (See page L15 for additional charges). Prices do not include cores. For IC Core pricing see pages L105 – L106. For Keying charges see page L115.

NM Series *List Price*

HEAVY DUTY, GRADE 1 MORTISE LOCKSET

► **PACKAGING INCLUDES**

- 6 locks per case
- UL listed single point latch
- Standard "C", 6-pin cylinder
- Non-handed strike

► **KEYWAYS**

6-pin solid brass "C" keyway standard. Optional: Schlage E, Schlage C-K, Russwin D1-2-3-4, Corbin 59 / 60, Arrow A, Corbin-Russwin L4, Sargent LA-LB-LC, Falcon / Weiser E, Yale 8, Yale GA and Kwikset. Can also accept Medeco, Assa, Kaba and **Cal-Royal HSK** High Security Cylinders. See **page L115** for keying charges and Cylinder PART #.

ADD \$60.00 List Each

When using 1 1/8" length Mortise cylinder for sectional trim and 1 1/4" length Mortise cylinder for Escutcheon **MUST USE CLOVER CAM** supplied by Cal-Royal.

Part # MCAM List \$4.50

► **IC CORE**

- For **Best, Falcon and Arrow** Interchangeable Core prefix "IC" before Part #.
(Mortise housing Part # ICH961387)
Add \$77.00 List

- For **Schlage** Large Format Interchangeable Core prefix "ICSC",
For **Corbin / Russwin** Large Format Interchangeable Core prefix "ICCR",
For **Sargent** Large Format Interchangeable Core prefix "ICSA",
For **Yale** Large Format Interchangeable Core prefix "ICYA"
before Part #.
(Mortise housing Part # 7000ICMC)
Add \$78.50 List

Price does not include Core.

Refer to pages L105 – L106 for Core prices.

Due to easy reversibility of NM Series, if handing is not available at time of shipment opposite hand will be shipped

► **QUICKMARK TEMPLATE**

Available heavy duty steel template for fast and easy installation. Reduces installation time. Eliminates using paper templates.

Part # MTCAL List \$130.00

► **OPTIONAL ADA THUMBTURN**

Add \$34.00List

Prefix "ADA" before Mortise lock ITEM#

Use Part # "ADATHUMB"

when ordering separately.

- FOR 2" up to 2 1/4" Thick door

Order kit:

SSMKIT214 - for sectional trim

SEMKIT214 - for escutcheon trim

LIST \$95.00

► **TACTILE**

Tactile: Part # TAC Add \$66.00 List

► **ELECTRIFIED**

Available on Storeroom Only

- Electrified Part # ELEC Add \$410.00List
(Specify Options)

FEATURES:

- UL and CSFM Listings
- Continuous duty solenoids for cooler operation during "continuously on" applications
- Standard plug-in rectifier allows for an AC or DC power source
- Low current draw
- Numerous switch options
- 3 year "No Hassle" warranty

OPTIONS:

- Voltage requirement -12 VAC / DC or 24 VAC / DC
- Amperage - 700mA @ 12V or 350mA @ 24V
- Function - available "Fail Safe" (FS) or "Fail Secure" (FSE)

- **REX - Request to Exit Add \$167.67List**
Available on NM8080 and NM8453 Functions

► **LEAD LINING**

- Part # LEAD Add \$326.00 List

► **ANTI MICROBIAL COATING**

Available on US26D and US32D finishes. **Add \$84.00 List.**

Prefix "ANTB" before Part #.

ADA THUMBTURN

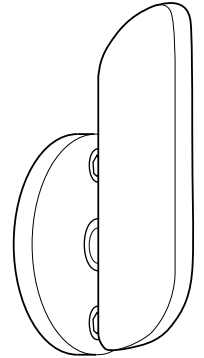

► **HOW TO ORDER**

1. Office Function
2. SS Trim Sectional
3. Satin Chrome
4. Right Handed

NM8050 – SS – US26D RH

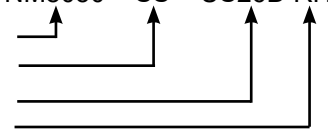

SC Series *List Price*

HEAVY DUTY, GRADE 1 MORTISE LOCKSET

**Optional Interchangeable Core Small Format (Best, Falcon and Arrow)
or Large Format (Schlage)**

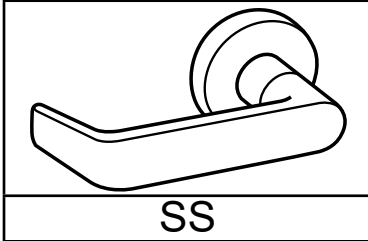

STOCK ITEM PRICES IN BOLD and SHADED AREAS
NON-STOCK FINISHES AVAILABLE WITH FACTORY LEAD TIME AND SUBJECT TO MINIMUM ORDER

SS SECTIONAL TRIM ONLY								
FUNCTIONS	ANSI	FINISHES						
		US26D	US32D	US32	US10B	US3	US26	US4
◀Single cylinder without deadbolt								
SC8050 - Office / Entrance	F04							
SC8070 - Classroom	F05	\$527.00	\$618.00	\$618.00	\$551.00	\$551.00	\$551.00	\$551.00
SC8080 - Storeroom	F07							
◀Single cylinder with deadbolt								
SC8453 - Entrance	F20							
SC8456 - Corridor	F13	543.00	662.00	662.00	577.00	577.00	577.00	577.00
SC8465 - Closet / Storeroom w/ DB	F65							
SC8495 - Privacy w/ Indicator	----							
SC8486 - Faculty Restroom w/ Indicator		709.00	828.00	828.00	745.00	745.00	745.00	745.00
SC8473 - Dormitory / Bedroom	F21	543.00	662.00	662.00	590.00	590.00	590.00	590.00
◀Double cylinder without deadbolt								
SC8060 - Apartment Entrance	F09							
SC8082 - Institution	F30							
SC8466 - Store Door Lock	F14	587.00	703.00	703.00	609.00	609.00	609.00	609.00
SC8071 - Classroom Security Lock	F32							
SC8457 - Classroom Security w/ DB	F33							
◀Other Functions								
SC8458 - Classroom w/ DB & Aux Latch	F34	586.00	703.00	703.00	609.00	609.00	609.00	609.00
SC8040 - Privacy with Deadbolt	F19	477.00	594.00	498.00	498.00	498.00	498.00	498.00
SC8445 - Privacy w/ Deadbolt, Coin turn & Indicator	---	642.00	749.00	749.00	673.50	673.50	673.50	673.50
SC8170 - Single Fixed Dummy	----	159.00	277.00	277.00	181.00	181.00	181.00	181.00
SC8010 - Passage	F01	424.00	541.00	541.00	447.00	447.00	447.00	447.00

Optional Interchangeable Cores (See page L21 for additional charges). Prices do not include cores. For IC Core pricing see pages L105 – L106. For Keying charges see page L115.

SC Series *List Price*

HEAVY DUTY, GRADE 1 MORTISE LOCKSET

Optional Interchangeable Core Small Format (Best, Falcon and Arrow) or Large Format (Schlage)

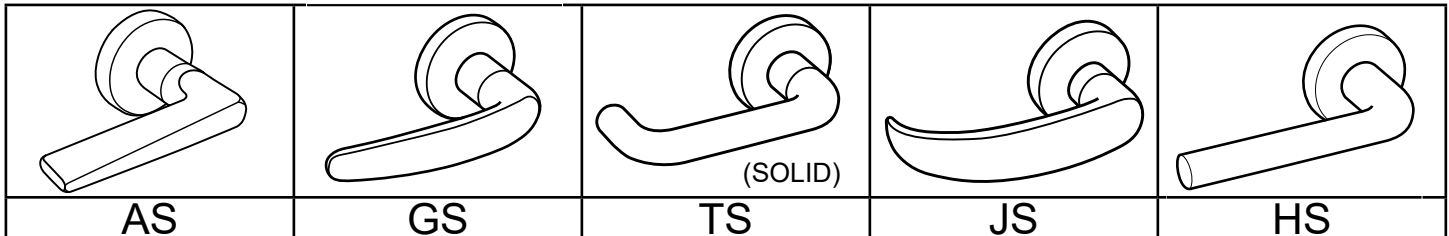

STOCK ITEM PRICES IN BOLD and SHADED AREAS
NON-STOCK FINISHES AVAILABLE WITH FACTORY LEAD TIME AND SUBJECT TO MINIMUM ORDER

AS, GS, TS, JS, HS SERIES SECTIONAL TRIM ONLY

FUNCTIONS	ANSI	FINISHES						
		US26D	US32D	US32	US10B	US3	US26	US4
◀Single cylinder without deadbolt								
SC8050 - Office / Entrance	F04							
SC8070 - Classroom	F05	\$527.00	\$618.00	\$618.00	\$551.00	\$551.00	\$551.00	\$551.00
SC8080 - Storeroom	F07							
◀Single cylinder with deadbolt								
SC8453 - Entrance	F20							
SC8456 - Corridor	F13	543.00	662.00	662.00	577.00	577.00	577.00	577.00
SC8465 - Closet / Storeroom w/ DB	F65							
SC8495 - Privacy w/ Indicator	----	709.00	828.00	828.00	745.00	745.00	745.00	745.00
SC8486 - Faculty Restroom w/ Indicator								
SC8473 - Dormitory / Bedroom	F21	543.00	662.00	662.00	590.00	590.00	590.00	590.00
◀Double cylinder without deadbolt								
SC8060 - Apartment Entrance	F09							
SC8082 - Institution	F30							
SC8466 - Store Door Lock	F14	587.00	703.00	703.00	609.00	609.00	609.00	609.00
SC8071 - Classroom Security Lock	F32							
SC8457 - Classroom Security w/ DB	F33							
◀Other Functions								
SC8458 - Classroom w/ DB & Aux Latch	F34	586.00	703.00	703.00	609.00	609.00	609.00	609.00
SC8040 - Privacy with Deadbolt	F19	477.00	594.00	498.00	498.00	498.00	498.00	498.00
SC8445 - Privacy w/ Deadbolt, Coin turn & Indicator	---	642.00	749.00	749.00	673.50	673.50	673.50	673.50
SC8170 - Single Fixed Dummy	----	159.00	277.00	277.00	181.00	181.00	181.00	181.00
SC8010 - Passage	F01	424.00	541.00	541.00	447.00	447.00	447.00	447.00

Optional Interchangeable Cores (See page L21 for additional charges). Prices do not include cores. For IC Core pricing see pages L105 – L106. For Keying charges see page L115.

SC Series *List Price*

HEAVY DUTY, GRADE 1 **WIDE ESCUTCHEON MORTISE LOCKSET**

Optional Interchangeable Core Small Format (Best, Falcon and Arrow) or Large Format (Schlage)

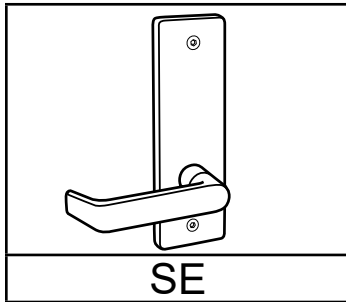

STOCK ITEM PRICES IN BOLD and SHADED AREAS
NON-STOCK FINISHES AVAILABLE WITH FACTORY LEAD TIME AND SUBJECT TO MINIMUM ORDER

SE WIDE ESCUTCHEON TRIM ONLY

FUNCTIONS	ANSI	FINISHES						
		US26D	US32D	US32	US10B	US3	US26	US4
◀Single cylinder without deadbolt								
SC8050 - Office / Entrance	F04							
SC8070 - Classroom	F05	\$585.00	\$703.00	\$703.00	\$609.00	\$609.00	\$609.00	\$609.00
SC8080 - Storeroom	F07							
◀Single cylinder with deadbolt								
SC8453 - Entrance	F20							
SC8456 - Corridor	F13	600.00	718.00	718.00	624.00	624.00	624.00	624.00
SC8465 - Closet / Storeroom w/ DB	F65							
SC8495 - Privacy w/ Indicator	----	773.00	903.00	903.00	809.00	809.00	809.00	809.00
SC8486 - Faculty Restroom w/ Indicator								
SC8473 - Dormitory / Bedroom	F21	600.00	718.00	718.00	624.00	624.00	624.00	624.00
◀Double cylinder without deadbolt								
SC8060 - Apartment Entrance	F09							
SC8082 - Institution	F30							
SC8466 - Store Door Lock	F14	628.00	746.00	746.00	651.78	651.78	651.78	651.78
SC8071 - Classroom Security Lock	F32							
SC8457 - Classroom Security w/ DB	F33							
◀Other Functions								
SC8458 - Classroom w/ DB & Aux Latch	F34	628.00	746.00	746.00	651.78	651.78	651.78	651.78
SC8040 - Privacy with Deadbolt	F19	562.00	679.00	679.00	587.00	587.00	587.00	587.00
SC8445 - Privacy w/ Deadbolt, Coin turn & Indicator	---	732.00	856.00	856.00	768.00	768.00	768.00	768.00
SC8170 - Single Fixed Dummy	----	187.00	305.00	305.00	211.00	211.00	211.00	211.00
SC8010 - Passage	F01	494.00	613.00	613.00	517.00	517.00	517.00	517.00

Optional Interchangeable Cores (See page L21 for additional charges). Prices do not include cores. For IC Core pricing see pages L105 – L106. For Keying charges see page L115.

SC Series *List Price*

HEAVY DUTY, GRADE 1 WIDE ESCUTCHEON MORTISE LOCKSET

Optional Interchangeable Core Small Format (Best, Falcon and Arrow) or Large Format (Schlage)

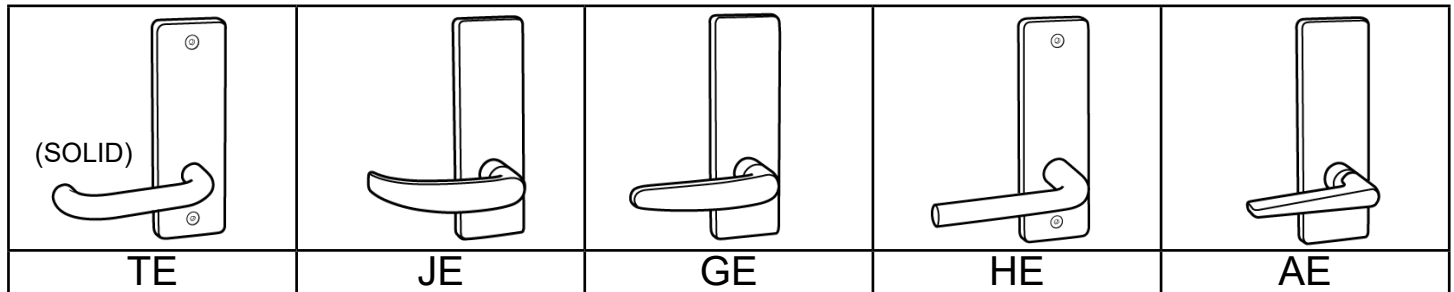

STOCK ITEM PRICES IN BOLD and SHADED AREAS
NON-STOCK FINISHES AVAILABLE WITH FACTORY LEAD TIME AND SUBJECT TO MINIMUM ORDER

SE WIDE ESCUTCHEON TRIM ONLY

FUNCTIONS	ANSI	FINISHES						
		US26D	US32D	US32	US10B	US3	US26	US4
◀Single cylinder without deadbolt								
SC8050 - Office / Entrance	F04							
SC8070 - Classroom	F05	\$585.00	\$703.00	\$703.00	\$609.00	\$609.00	\$609.00	\$609.00
SC8080 - Storeroom	F07							
◀Single cylinder with deadbolt								
SC8453 - Entrance	F20							
SC8456 - Corridor	F13	600.00	718.00	718.00	624.00	624.00	624.00	624.00
SC8465 - Closet / Storeroom w/ DB	F65							
SC8495 - Privacy w/ Indicator	----	773.00	903.00	903.00	809.00	809.00	809.00	809.00
SC8486 - Faculty Restroom w/ Indicator	----							
SC8473 - Dormitory / Bedroom	F21	600.00	718.00	718.00	624.00	624.00	624.00	624.00
◀Double cylinder without deadbolt								
SC8060 - Apartment Entrance	F09							
SC8082 - Institution	F30							
SC8466 - Store Door Lock	F14	628.00	746.00	746.00	651.78	651.78	651.78	651.78
SC8071 - Classroom Security Lock	F32							
SC8457 - Classroom Security w/ DB	F33							
◀Other Functions								
SC8458 - Classroom w/ DB & Aux Latch	F34	628.00	746.00	746.00	651.78	651.78	651.78	651.78
SC8040 - Privacy with Deadbolt	F19	562.00	679.00	679.00	587.00	587.00	587.00	587.00
SC8445 - Privacy w/ Deadbolt, Coin turn & Indicator	---	732.00	856.00	856.00	768.00	768.00	768.00	768.00
SC8170 - Single Fixed Dummy	----	187.00	305.00	305.00	211.00	211.00	211.00	211.00
SC8010 - Passage	F01	494.00	613.00	613.00	517.00	517.00	517.00	517.00

Optional Interchangeable Cores (See page L21 for additional charges). Prices do not include cores. For IC Core pricing see pages L105 – L106. For Keying charges see page L115.

SC Series *List Price*

HEAVY DUTY, GRADE 1 MORTISE DEADBOLTS

Optional Interchangeable Core Small Format (Best, Falcon and Arrow) or Large Format (Schlage)

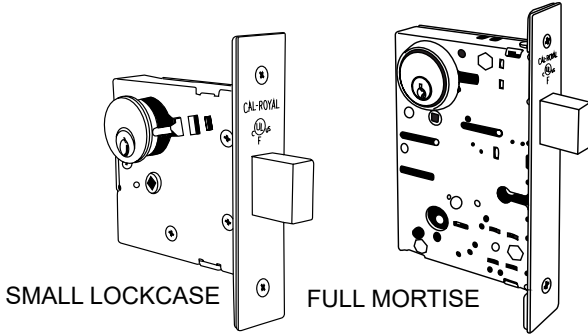

STOCK ITEM PRICES IN BOLD and SHADED AREAS
NON-STOCK FINISHES AVAILABLE WITH FACTORY LEAD TIME AND SUBJECT TO MINIMUM ORDER

MODEL#	ANSI	LIST PRICE EACH		FUNCTIONS	MODEL#	ANSI	LIST PRICE EACH		
		US26D, 32D	US10B, 3, 26, 4				US26D	US32D	US10B, 3, 26, 4
SM140	1	\$192.00	\$211.00	Cylinder and Thumbturn Deadbolt thrown or retracted by key outside or thumbturn inside.	SC8460	F17	\$255.00	\$255.00	\$279.00
SM143	1	213.00	234.00	Double Cylinder Deadbolt operated by key on either side.	SC8462	F16	270.00	270.00	298.00
SM141	1	213.00	234.00	Classroom Lock Deadbolt thrown or retracted by key from outside. Inside cylinder turn retracts deadbolt but cannot project it.	SC8463	F29	270.00	270.00	298.00
SM142	1	181.00	200.00	Cylinder Lock Deadbolt thrown or retracted by key from one side. No trim on opposite side.	SC8464	F18	247.00	247.00	272.00
SM145	1	170.00	187.00	Door Bolt Deadbolt thrown or retracted by thumbturn from one side. No trim on opposite side.	SC8461	1	436.00	436.00	479.00
SM146	1	353.00	397.00	Deadbolt with "OCCUPIED" indicator Deadbolt thrown or retracted by key outside or thumbturn inside. "OCC" plate is displayed when deadbolt is thrown.	SC8496	1	436.00	436.00	479.00

All keyed lock functions are available with Best, Falcon and Arrow, Schlage, Corbin / Russwin, Sargent, and Yale Large Format Interchangeable Cores (See page L21 for additional charges). Prices do not include cores. For IC Core pricing see pages L105 – L106. For Keying charges see page L115.

SC Series *List Price*

HEAVY DUTY, GRADE 1 MORTISE LOCKSET WITH CLUTCH

Optional Interchangeable Core Small Format (Best, Falcon and Arrow) or Large Format (Schlage)

► **PACKAGING INCLUDES**

- 6 locks per case
- UL listed single point latch
- Standard "C", 6-pin cylinder
- Non-handed strike

► **KEYWAYS**

6-pin solid brass "C" keyway standard. Optional: Schlage E, Schlage C-K, Russwin D1-2-3-4, Corbin 59 / 60, Arrow A, Corbin-Russwin L4, Sargent LA-LB-LC, Falcon / Weiser E, Yale 8, Yale GA and Kwikset. Can also accept Medeco, Assa, Kaba and **Cal-Royal HSK** High Security Cylinders. See **page L115** for keying charges and Cylinder PART #.

ADD \$60.00 List Each

► When using 1 1/8" length Mortise cylinder for sectional trim and 1 1/4" length Mortise cylinder for Escutcheon **MUST USE SCHLAGE CAM** supplied by Cal-Royal.

Part # KCS7 List \$4.50

► **IC CORE**

For **Best, Falcon and Arrow** Interchangeable Core prefix "**IC**" before **Part #**.

(Mortise housing **Part # ICH961387**)

Add \$77.00 List

For **Schlage** Large Format Interchangeable Core prefix "**ICSC**", For **Corbin / Russwin** Large Format Interchangeable Core prefix "**ICCR**", For **Sargent** Large Format Interchangeable Core prefix "**ICSA**", For **Yale** Large Format Interchangeable Core prefix "**ICYA**" before **Part #**.

(Mortise housing **Part # 7000ICMC**)

Add \$78.50List

Price does not include Core.

Refer to pages L105 – L106 for Core prices.

► **LEAD LINING**

- Part # LEAD Add \$326.00List

Due to easy reversibility of SC Series, if handing is not available at time of shipment opposite hand will be shipped. ALL PRODUCTS ARE SHIPPED NON-HANDED. EASILY FIELD REVERSIBLE

► FOR 2" up to 2 1/4" Thick door

Order kit:

SCSKIT200 - for sectional trim

SCEKIT214 - for escutcheon trim

LIST \$55.00

► **OPTIONAL ADA THUMBTURN**

ADD \$35.00List

Prefix "**ADA**" before Mortise lock **ITEM#**

Use **Part # "SCADA"** when ordering separately.

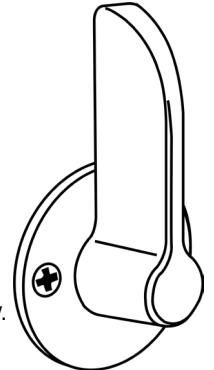

SCADA THUMBTURN

► **TACTILE**

Tactile: Part # TAC Add \$66.00 List

► **ELECTRIFIED**

Available on Storeroom Only

- Electrified Part # ELEC Add \$410.00List (Specify Options)

FEATURES:

- UL and CSFM Listings
- Continuous duty solenoids for cooler operation during "continuously on" applications
- Standard plug-in rectifier allows for an AC or DC power source
- Low current draw
- Numerous switch options
- 3 year "No Hassle" warranty

OPTIONS:

- Voltage requirement -12 VAC / DC or 24 VAC / DC
- Amperage - 700mA @ 12V or 350mA @ 24V
- Function - available "Fail Safe" (FS) or "Fail Secure" (FSE)

- **REX - Request to Exit Add \$167.67 List**

Available on SC8080 and SC8453 Functions

► **ANTI MICROBIAL COATING**

Available on US26D and US32D finishes. **Add \$84.00List.**

Prefix "**ANTB**" before **Part #**.







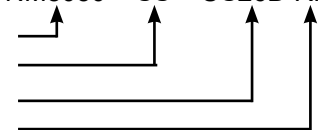





► **HOW TO ORDER**

1. Office Function
2. SS Trim Sectional
3. Satin Chrome
4. Right Handed

NM8050 – SS – US26D RH



Heavy Duty Mortise Lock COMPARISON CHART

FUNCTION	ILLUSTRATION	ANSI NO.	CAL-ROYAL MODEL NO	NT FALCON M SERIES	ARROW B Series	CORBIN/RUSSWIN	SARGENT 7800 / 8200	SCHLAGE L SERIES	PDQ MR SERIES	YALE	HAGER
ENTRANCE or OFFICE		Single Cylinder Without Deadbolt									
		F04	SC8050	M521	BM22	ML2051	5	L9050	MR116	8807	3850
CLASSROOM		F05	SC8070	M561	BM17	ML2055	37	L9070	MR148	8808	3870
STOREROOM or CLOSET		F07	SC8080	M371	BM12	ML2057	4	L9080	MR115	8805	3880
APARTMENT / DORMITORY		Single Cylinder With Deadbolt									
		F20	SC8453	M531	BM11	ML2067	45	L9453	MR162	8847	3853
DORMITORY / BEDROOM		F21	SC8473	M541	BM20	ML2024	24	L9473	MR135	8860	---
CORRIDOR / EXIT		F13	SC8456	M571	BM19	ML2065	25	L9456	MR136	8822	
KEYED PRIVACY INDICATOR		---	SC8495	M451	---	ML2024 M19	---	L9495 L9496	---	8864	---
CLOSET / STOREROOM		---	SC8465	---	---	---	27	L9465	MR139	---	---
APARTMENT ENTRANCE / VESTIBULE		Double Cylinder Without Deadbolt									
		F09	SC8060	M381	BM32	ML2042	16	L9060	MR186	8817	----
INSTITUTION		F30	SC8082	M411	BM33	ML2032	17	L9082	---	8830-2	3882
STOREROOM UTILITY		Double Cylinder With Deadbolt									
		F14	SC8466	M371	BM31	ML2022	26	L9466	MR137	8860	----
PRIVACY or BATHROOM		Other Functions									
		F02 F19 F22	SC8040	M311	BM02	ML2020	65	L9040	MR178 MR179	8802	3840
		----	SC8445	----	----	ML2020 M19	49	----	----	8862	3896
PASSAGE or CLOSET		F01	SC8010	M101	BM01	ML2010	13	L9010	MR126	8801	3810
SINGLE FIXED DUMMY		----	SC8170	M12	BM08	ML2050	93	L0170	MR211	8855	3817
DOUBLE FIXED DUMMY		---	SC8172	M18	BM09	ML2070	96	L0172	MR205	8838	3827

HL Series *List Price*

HOSPITAL LATCH (HL TRIM)
HEAVY DUTY, GRADE 1 MORTISE LOCKSET

**Optional Interchangeable Core Small Format (Best, Falcon and Arrow)
or Large Format (Schlage)**

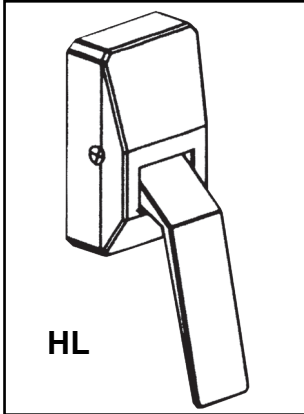

STOCK ITEM PRICES IN **BOLD**

NON-STOCK FINISHES AVAILABLE WITH FACTORY LEAD TIME AND SUBJECT TO MINIMUM ORDER

HL SERIES TRIM ONLY

FUNCTIONS	ANSI	FINISHES						
		US26D	US32D	US32	US10B	US3	US26	US4
◀Single cylinder without deadbolt								
SC8070HL - Classroom Lock	F05	\$1224.0	1446.00	\$1446.00	\$1224.00	\$1285.00	\$1285.00	1285.00
◀Single cylinder with deadbolt								
SC8453HL - Entrance	F20	1265.00	1554.90	1554.90	1265.00	1324.00	1324.00	1324.00
SC8456HL - Corridor	F13							
SC8473HL - Dormitory / Bedroom	F21							
SC8050HL - Office / Entrance	F04	1224.00	1446.00	1446.00	1224.00	1285.00	1285.00	1285.00
◀Double cylinder without deadbolt								
SC8060HL - Apartment Entrance	F09	1369.00	1659.00	1659.00	1369.00	1427.00	1427.00	1427.00
SC8082HL - Institution	F30							
◀Double cylinder with deadbolt								
SC8411HL - Dormitory or Exit Lock	F11	1431.00	1735.00	1735.00	1431.00	1488.00	1488.00	1488.00
SC8466HL - Store Door Lock	F14	1369.00	1659.00	1659.00	1369.00	1427.00	1427.00	1427.00
◀Other Functions								
SC8040HL - Privacy with Deadbolt	F19	1099.00	1388.00	1388.00	1099.00	1156.00	1156.00	1156.00
SC8049HL - Privacy Bedroom / Bath	F22	1156.00	1456.00	1456.00	1156.00	1216.00	1216.00	1216.00
SC8010HL - Passage	F01	969.00	1260.00	1260.00	969.00	1026.00	1026.00	1026.00

Optional Interchangeable Cores (See page L15 for additional charges). Prices do not include cores. For IC Core pricing see pages L105 – L106. For Keying charges see page L115.

LG Series *List Price*

ANTI-LIGATURE LG TRIM

HEAVY DUTY, GRADE 1 MORTISE LOCKSET

Optional Interchangeable Core Small Format (Best, Falcon and Arrow) or Large Format (Schlage)

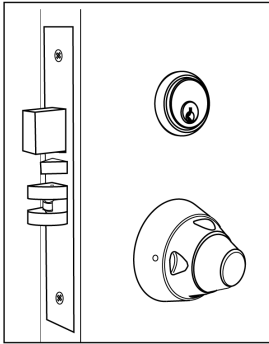

LGK



LGX

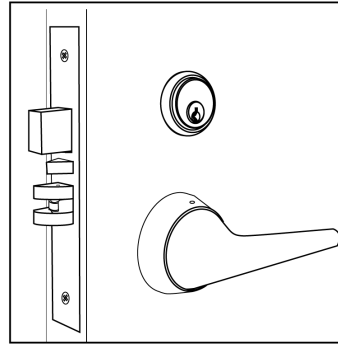

LGS

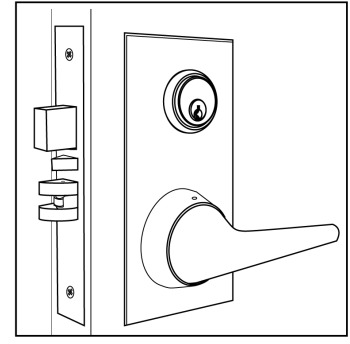

LGE

STOCK ITEM PRICES IN BOLD

NON-STOCK FINISHES AVAILABLE WITH FACTORY LEAD TIME AND SUBJECT TO MINIMUM ORDER

LG SERIES TRIM ONLY

FUNCTIONS	ANSI	US32D FINISH			
		LGK	LGX	LGS	LGE
◀Single cylinder without deadbolt					
SC8070LG – Classroom Lock	F05				
SC8007LG – Storeroom Lock	F07	1452.00	1887.00	\$1561.00	\$1995.00
SC8026LG – Supervisor Office or Privacy Room	F26	1616.00	2051.00	1735.00	2147.00
◀Single cylinder with deadbolt					
SC8050LG – Office / Entrance	F04	1452.00	1887.00	1561.00	1995.00
SC8456LG - Corridor	F13				
SC8453LG - Entrance	F20	1497.00	1932.00	1606.00	2040.00
SC8473LG - Dormitory / Bedroom	F21				
SC8465LG - Closet / Storeroom w/ DB	F65	1616.00	2051.00	1735.00	2147.00
◀Double cylinder without deadbolt					
SC8060LG - Apartment Entrance	F09				
SC8082LG - Institution / Asylum	F30	1616.00	2051.00	1735.00	2147.00
SC8083LG – Lockable Patient Room	F32				
◀Double cylinder with deadbolt					
SC8411LG – Dormitory or Exit Lock	F11	1616.00	2051.00	1735.00	2147.00
SC8457LG – Classroom Security Intruder Deadbolt	F33	1616.00	2051.00	1735.00	2147.00
◀Other Functions					
SC8458LG - Classroom w/ DB & Aux Latch	F34	1616.00	2051.00	1735.00	2147.00
SC8010LG – Passage Latch	F01	1344.00	1778.00	1452.00	1887.00
SC8049LG – Privacy with Deadbolt	F19	1388.00	1823.00	1497.00	1931.00
SC8040LG – Privacy	F22	1388.00	1823.00	1497.00	1931.00

All keyed lock functions are available with Best, Falcon and Arrow, Schlage, Corbin / Russwin, Sargent, and Yale Large Format Interchangeable Cores (See page L21 for additional charges). Prices do not include cores. For IC Core pricing see pages L105 – L106. For Keying charges see page L115.

LG Series *List Price*

ANTI-LIGATURE LG TRIM

HEAVY DUTY, GRADE 1 MORTISE LOCKSET

Optional Interchangeable Core Small Format (Best, Falcon and Arrow) or Large Format (Schlage)

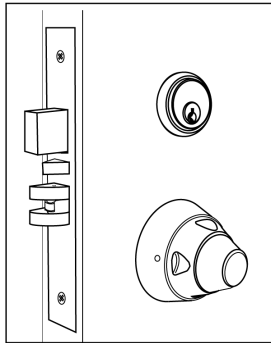

LGK

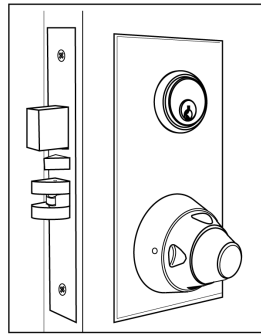

LGX

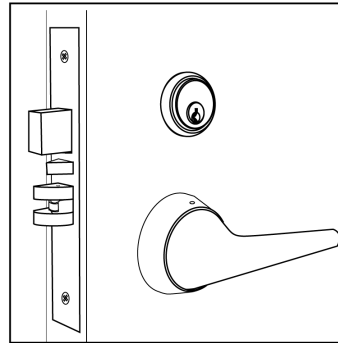

LGS

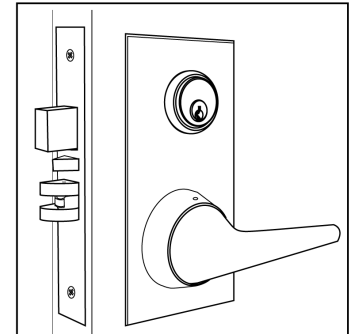

LGE

STOCK ITEM PRICES IN **BOLD**

NON-STOCK FINISHES AVAILABLE WITH FACTORY LEAD TIME AND SUBJECT TO MINIMUM ORDER

LG SERIES TRIM ONLY

FUNCTIONS					ANSI	US32D FINISH			
◀For Asylum use only no free exit					IT-Inside Thumbturn IL-Inside Lever IC-Inside Cylinder OC-Outside Cylinder				
	IT	IL	IC	OC		LGK	LGX	LGS	LGE
SC8031LG – Asylum		✓		✓	Asylum-1	2104.00	\$2 436.00	\$2 191.00	\$2 524.00
SC8032LG – Asylum			✓	✓	Asylum-2	2104.00	2 436.00	2 191.00	2 524.00
SC8033LG – Asylum				✓	Asylum-3	2104.00	2 436.00	2 191.00	2 524.00
SC8466LG – Store Door Lock		✓	✓	✓	Asylum-4 (F14)	1616.00	2 051.00	1 735.00	2 147.00
SC8467LG – Asylum w/ deadbolt		✓		✓	Asylum-5 w/ deadbolt	2115.00	2 447.00	2 204.00	2 536.00
SC8468LG – Asylum w/ deadbolt		✓		✓	Asylum-6 w/ deadbolt	2115.00	2 447.00	2 204.00	2 536.00
SC8469LG – Asylum w/ deadbolt				✓	Asylum-7 w/ deadbolt	2115.00	2 447.00	2 204.00	2 536.00
◀Other Keyed Functions									
SC8055LG – Female Patient Rm1	✓	✓		✓	Female Patient Room-1	1616.00	2 051.00	1 735.00	2 147.00
SC8056LG – Female Patient Rm2	✓	✓		✓	Female Patient Room-2	1616.00	2 051.00	1 735.00	2 147.00

All keyed lock functions are available with Best, Falcon and Arrow, Schlage, Corbin / Russwin, Sargent, and Yale Large Format Interchangeable Cores (See page L15 for additional charges). Prices do not include cores. For IC Core pricing see pages L105 – L106. For Keying charges see page L115.

HOSPITAL PUSH / PULL LATCH

FOR 1 3/4" THICK DOORS



FEATURES

- UL-listed for use on all fire doors
- Meets ADA requirements
- Ideal for use in hospitals, washrooms or public buildings
- 6 possible PUSH-PULL mounting combinations
- Covers and paddles are made of stainless steel
- Non-Handed
- Standard T-Strike and plastic dust box
- 1 3/4" door thickness
- 2 3/4" backset standard, face plate 1 1/8" x 2 1/4"
- Optional 5" backsets
- 2 5/8" X 4 3/8" Covers
- 2 5/8" Handle Projection

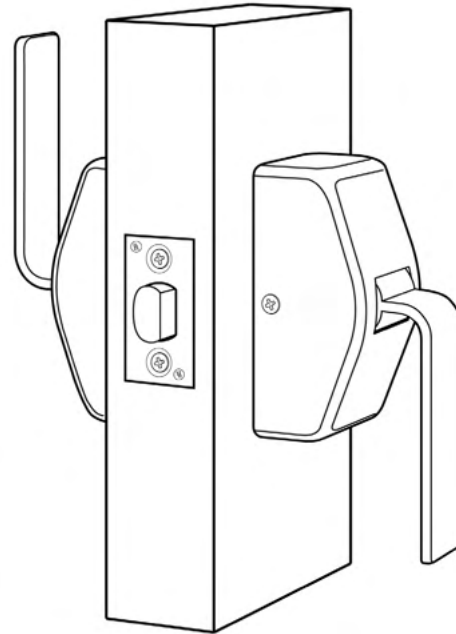











OPTIONS AVAILABLE

- Lead Lining
- Anti-Microbial
- ASA Strike

ITEM#	FUNCTIONS	DESCRIPTION	LIST PRICE EACH	PCS / INNER BOX	PCS / MC	UOM
			US32D			
HOS-PP30	Passage	Hospital Push / Pull Latch, Non-Handed Passage Function, UL- Listed, 2 3/4" or 5" Backset	\$381.00	1	10	Ea.
ULHOS-PAS-5	Latchbolt	UL- Listed 5" Backset Privacy / Passage Latch	72.00	20	100	
ULHOS-PAS-234		UL- Listed 2 3/4" Backset Privacy / Passage Latch	72.00	20	100	
HOS-ANTB	Add on	Anti Microbial Coating (Inside and Outside surfaces)	84.00			
HOS-LEAD		LEAD LINING	338.00			
ASAST	Strike	ASA ANSI Strike	7.50			
EXASA-175	Strike	Extended Lip ANSI Strike	US32D, DURO 45.00			

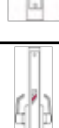
Heavy Duty Mortise Lock COMPARISON CHART

FUNCTION	ILLUSTRATION	ANSI NO.	CAL-ROYAL MODEL NO	NT FALCON M SERIES	ARROW B Series	CORBIN/RUSSWIN	SARGENT 7800 / 8200	SCHLAGE L SERIES	PDQ MR SERIES	YALE	HAGER
ENTRANCE or OFFICE		Single Cylinder Without Deadbolt									
		F04	NM8050	M521	BM22	ML2051	5	L9050	MR116	8807	3850
CLASSROOM		F05	NM8070	M561	BM17	ML2055	37	L9070	MR148	8808	3870
STOREROOM or CLOSET		F07	NM8080	M371	BM12	ML2057	4	L9080	MR115	8805	3880
APARTMENT / DORMITORY		Single Cylinder With Deadbolt									
		F20	NM8453	M531	BM11	ML2067	45	L9453	MR162	8847	3853
DORMITORY / BEDROOM		F21	NM8473	M541	BM20	ML2024	24	L9473	MR135	8860	---
CORRIDOR / EXIT		F13	NM8456	M571	BM19	ML2065	25	L9456	MR136	8822	---
KEYED PRIVACY INDICATOR		---	NM8495	M451	---	ML2024 M19	---	L9495 L9496	---	8864	---
CLOSET / STOREROOM		---	NM8465	---	---	---	27	L9465	MR139	---	---
APARTMENT ENTRANCE / VESTIBULE		Double Cylinder Without Deadbolt									
		F09	NM8060	M381	BM32	ML2042	16	L9060	MR186	8817	----
INSTITUTION		F30	NM8082	M411	BM33	ML2032	17	L9082	---	8830-2	3882
STOREROOM UTILITY		Double Cylinder With Deadbolt									
		F14	NM8466	M371	BM31	ML2022	26	L9466	MR137	8860	----
PRIVACY or BATHROOM		Other Functions									
		F02 F19 F22	NM8040	M311	BM02	ML2020	65	L9040	MR178 MR179	8802	3840
PRIVACY WITH INDICATOR		----	NM8445	----	----	ML2020 M19	49	----	----	8862	3896
PASSAGE or CLOSET		F01	NM8010	M101	BM01	ML2010	13	L9010	MR126	8801	3810
SINGLE FIXED DUMMY		----	NM8170	M12	BM08	ML2050	93	L0170	MR211	8855	3817
DOUBLE FIXED DUMMY		---	NM8172	M18	BM09	ML2070	96	L0172	MR205	8838	3827

GENESYS Series *List Price*

HEAVY DUTY CYLINDRICAL LEVERSETS WITH CLUTCH

ANSI - A156.2, SERIES 4000, GRADE 1

Optional Interchangeable Core for **Best, Falcon and Arrow**

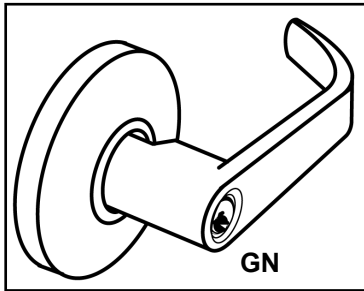

STOCK ITEM PRICES IN BOLD.

NON-STOCK FINISHES AND DESIGNS AVAILABLE WITH FACTORY LEAD TIME AND SUBJECT TO MINIMUM ORDER

FUNCTIONS	ANSI	ITEM#	US26D	US10B	US3	US10	US26	US4	PCS / MC
Entrance	F109	CGN00	\$347.00	\$364.00	\$364.00	\$364.00	\$364.00	\$364.00	10
		ICCGN00	347.00	364.00	364.00	364.00	364.00	364.00	
Entrance Push Button Lock	F82	CGN01	347.00	364.00	364.00	364.00	364.00	364.00	
		ICCGN01	347.00	364.00	364.00	364.00	364.00	364.00	
Store lock Non Clutch (keyed Dbl. cyl.)	F91	GN02	408.00	428.00	428.00	428.00	428.00	428.00	
		ICGN02	408.00	428.00	428.00	428.00	428.00	428.00	
Classroom	F84	CGN03	357.00	375.00	375.00	375.00	375.00	375.00	
		ICCGN03	357.00	375.00	375.00	375.00	375.00	375.00	
Communicating (keyed Dbl. cyl.)	F80	CGN04	408.00	428.00	428.00	428.00	428.00	428.00	
		ICCGN04	408.00	428.00	428.00	428.00	428.00	428.00	
Storeroom	F86	CGN05	347.00	364.00	364.00	364.00	364.00	364.00	
		ICCGN05	347.00	364.00	364.00	364.00	364.00	364.00	
Vestibule	F88	CGN06	408.00	428.00	428.00	428.00	428.00	428.00	
		ICCGN06	408.00	428.00	428.00	428.00	428.00	428.00	
Classroom / Intruder	F110	CGN07	408.00	428.00	428.00	428.00	428.00	428.00	
		ICCGN07	408.00	428.00	428.00	428.00	428.00	428.00	
Dormitory (Non-Clutch)	F90	GN101	357.00	375.00	375.00	375.00	375.00	375.00	
Institution (keyed Dbl. cyl.)	F87	CGN09	408.00	428.00	428.00	428.00	428.00	428.00	
		ICCGN09	408.00	428.00	428.00	428.00	428.00	428.00	
Privacy	F76	CGN20	322.00	334.00	334.00	334.00	334.00	334.00	
Hospital Privacy	---	HCGN20	347.00	373.00	373.00	373.00	373.00	373.00	
Passage	F75	GN30	264.00	281.00	281.00	281.00	281.00	281.00	
Exit	F89	GN50	264.00	281.00	281.00	281.00	281.00	281.00	
Single Dummy	----	GN40	87.00	94.00	94.00	94.00	94.00	94.00	20

Ⓢ (IC) Indicates function available with Best, Falcon and Arrow Interchangeable Core. Prices do not include cores. For IC Core pricing see pages L105 – L106. For Keying charges see page L115.

HEAVY DUTY CYLINDRICAL LEVERSETS WITH CLUTCH ANSI - A156.2, SERIES 4000, GRADE 1

● Optional Interchangeable Core for **Best, Falcon and Arrow**

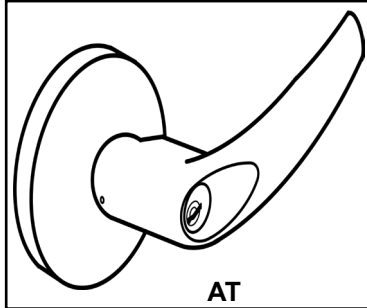

LIFETIME WARRANTY

BHMA™ CERTIFIED
Be Safe. Be Secure. Look for the Mark.

MEETS
The Buy American Act



STOCK ITEM PRICES IN BOLD.
NON-STOCK FINISHES AND DESIGNS AVAILABLE WITH FACTORY LEAD TIME AND SUBJECT TO MINIMUM ORDER

FUNCTIONS	ANSI	ITEM#	US26D	US10B	US3	US10	US26	US4	PCS / MC
Entrance	F109	CAT00	\$347.00	\$364.00	\$364.00	\$364.00	\$364.00	\$364.00	10
		● ICCAT00	347.00	364.00	364.00	364.00	364.00	364.00	
Entrance Push Button Lock	F82	CAT01	347.00	364.00	364.00	364.00	364.00	364.00	
		● ICCAT01	347.00	364.00	364.00	364.00	364.00	364.00	
Store lock Non Clutch (keyed Dbl. cyl.)	F91	AT02	408.00	428.00	428.00	428.00	428.00	428.00	
		● ICAT02	408.00	428.00	428.00	428.00	428.00	428.00	
Classroom	F84	CAT03	357.00	375.00	375.00	375.00	375.00	375.00	
		● ICCAT03	357.00	375.00	375.00	375.00	375.00	375.00	
Communicating (keyed Dbl. cyl.)	F80	CAT04	408.00	428.00	428.00	428.00	428.00	428.00	
		● ICCAT04	408.00	428.00	428.00	428.00	428.00	428.00	
Storeroom	F86	CAT05	347.00	364.00	364.00	364.00	364.00	364.00	
		● ICCAT05	347.00	364.00	364.00	364.00	364.00	364.00	
Vestibule	F88	CAT06	408.00	428.00	428.00	428.00	428.00	428.00	
		● ICCAT06	408.00	428.00	428.00	428.00	428.00	428.00	
Classroom / Intruder	F110	CAT07	408.00	428.00	428.00	428.00	428.00	428.00	
		● ICCAT07	408.00	428.00	428.00	428.00	428.00	428.00	
Institution (keyed Dbl. cyl.)	F87	CAT09	408.00	428.00	428.00	428.00	428.00	428.00	
		● ICCAT09	408.00	428.00	428.00	428.00	428.00	428.00	
Privacy	F76	CAT20	322.00	334.00	334.00	334.00	334.00	334.00	
Hospital Privacy	---	HCAT20	347.00	373.00	373.00	373.00	373.00	373.00	
Passage	F75	AT30	264.00	281.00	281.00	281.00	281.00	281.00	
Exit	F89	AT50	264.00	281.00	281.00	281.00	281.00	281.00	
Single Dummy	----	AT40	87.00	94.00	94.00	94.00	94.00	94.00	20

● (IC) Indicates function available with **Best, Falcon and Arrow** Interchangeable Core. Prices do not include cores. For IC Core pricing see pages L105 – L106. For Keying charges see page L115.

HEAVY DUTY CYLINDRICAL LEVERSETS WITH CLUTCH

ANSI - A156.2, SERIES 4000, GRADE 1

Optional Interchangeable Core for **Best, Falcon and Arrow**

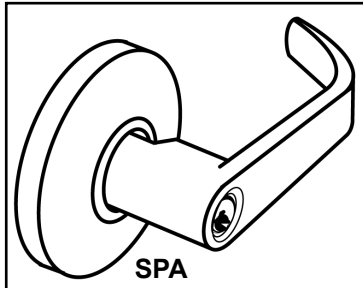

STOCK ITEM PRICES IN BOLD.

NON-STOCK FINISHES AND DESIGNS AVAILABLE WITH FACTORY LEAD TIME AND SUBJECT TO MINIMUM ORDER

FUNCTIONS	ANSI	ITEM#	US26D	US10B	US3	US10	US26	US4	PCS / MC
Entrance	F109	CSPA00	\$347.00	\$364.00	\$364.00	\$364.00	\$364.00	\$364.00	10
		● ICSPA00	347.00	364.00	364.00	364.00	364.00	364.00	
Entrance Push Button Lock	F82	CSPA01	347.00	364.00	364.00	364.00	364.00	364.00	
		● ICSPA01	347.00	364.00	364.00	364.00	364.00	364.00	
Store lock Non Clutch (keyed Dbl. cyl.)	F91	SPA02	408.00	428.00	428.00	428.00	428.00	428.00	
		● ICSPA02	408.00	428.00	428.00	428.00	428.00	428.00	
Classroom	F84	CSPA03	357.00	375.00	375.00	375.00	375.00	375.00	
		● ICSPA03	357.00	375.00	375.00	375.00	375.00	375.00	
Communicating (keyed Dbl. cyl.)	F80	CSPA04	408.00	428.00	428.00	428.00	428.00	428.00	
		● ICSPA04	408.00	428.00	428.00	428.00	428.00	428.00	
Storeroom	F86	CSPA05	347.00	364.00	364.00	364.00	364.00	364.00	
		● ICSPA05	347.00	364.00	364.00	364.00	364.00	364.00	
Vestibule	F88	CSPA06	408.00	428.00	428.00	428.00	428.00	428.00	
		● ICSPA06	408.00	428.00	428.00	428.00	428.00	428.00	
Classroom / Intruder	F110	CSPA07	408.00	428.00	428.00	428.00	428.00	428.00	
		● ICSPA07	408.00	428.00	428.00	428.00	428.00	428.00	
Institution (keyed Dbl. cyl.)	F87	CSPA09	408.00	428.00	428.00	428.00	428.00	428.00	
		● ICSPA09	408.00	428.00	428.00	428.00	428.00	428.00	
Privacy	F76	CSPA20	322.00	334.00	334.00	334.00	334.00	334.00	
Hospital Privacy	---	HCSA20	347.00	373.00	373.00	373.00	373.00	373.00	
Passage	F75	SPA30	264.00	281.00	281.00	281.00	281.00	281.00	
Exit	F89	SPA50	264.00	281.00	281.00	281.00	281.00	281.00	
Single Dummy	----	SPA40	87.00	94.00	94.00	94.00	94.00	94.00	20

● (IC) Indicates function available with Best, Falcon and Arrow Interchangeable Core. Prices do not include cores. For IC Core pricing see pages L105 – L106. For Keying charges see page L115.

HEAVY DUTY CYLINDRICAL LEVERSETS WITH CLUTCH ANSI - A156.2, SERIES 4000, GRADE 1

Optional Interchangeable Core for **Best, Falcon and Arrow**

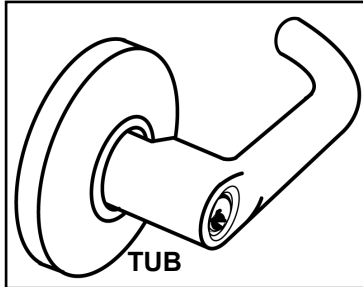

LIFETIME WARRANTY



MEETS
The Buy American Act



STOCK ITEM PRICES IN BOLD.
NON-STOCK FINISHES AND DESIGNS AVAILABLE WITH FACTORY LEAD TIME AND SUBJECT TO MINIMUM ORDER

FUNCTIONS	ANSI	ITEM#	US26D	US10B	US3	US10	US26	US4	PCS / MC
Entrance	F109	CTUB00	\$347.00	\$364.00	\$364.00	\$364.00	\$364.00	\$364.00	10
		ICCTUB00	347.00	364.00	364.00	364.00	364.00	364.00	
Entrance Push Button Lock	F82	CTUB01	347.00	364.00	364.00	364.00	364.00	364.00	
		ICCTUB01	347.00	364.00	364.00	364.00	364.00	364.00	
Store lock Non Clutch (keyed Dbl. cyl.)	F91	TUB02	408.00	428.00	428.00	428.00	428.00	428.00	
		ICTUB02	408.00	428.00	428.00	428.00	428.00	428.00	
Classroom	F84	CTUB03	357.00	375.00	375.00	375.00	375.00	375.00	
		ICCTUB03	357.00	375.00	375.00	375.00	375.00	375.00	
Communicating (keyed Dbl. cyl.)	F80	CTUB04	408.00	428.00	428.00	428.00	428.00	428.00	
		ICCTUB04	408.00	428.00	428.00	428.00	428.00	428.00	
Storeroom	F86	CTUB05	347.00	364.00	364.00	364.00	364.00	364.00	
		ICCTUB05	347.00	364.00	364.00	364.00	364.00	364.00	
Vestibule	F88	CTUB06	408.00	428.00	428.00	428.00	428.00	428.00	
		ICCTUB06	408.00	428.00	428.00	428.00	428.00	428.00	
Classroom / Intruder	F110	CTUB07	408.00	428.00	428.00	428.00	428.00	428.00	
		ICCTUB07	408.00	428.00	428.00	428.00	428.00	428.00	
Institution (keyed Dbl. cyl.)	F87	CTUB09	408.00	428.00	428.00	428.00	428.00	428.00	
		ICCTUB09	408.00	428.00	428.00	428.00	428.00	428.00	
Privacy	F76	CTUB20	322.00	334.00	334.00	334.00	334.00	334.00	
Hospital Privacy	---	HCTUB20	347.00	373.00	373.00	373.00	373.00	373.00	
Passage	F75	TUB30	264.00	281.00	281.00	281.00	281.00	281.00	
Exit	F89	TUB50	264.00	281.00	281.00	281.00	281.00	281.00	
Single Dummy	----	TUB40	87.00	94.00	94.00	94.00	94.00	94.00	20

IC indicates function available with Best, Falcon and Arrow Interchangeable Core. Prices do not include cores. For IC Core pricing see pages L105 – L106. For Keying charges see page L115.

HEAVY DUTY CYLINDRICAL LEVERSETS WITH CLUTCH ANSI - A156.2, SERIES 4000, GRADE 1

Optional Full Size Interchangeable Core for **Corbin/Ruswin, Sargent and Yale**

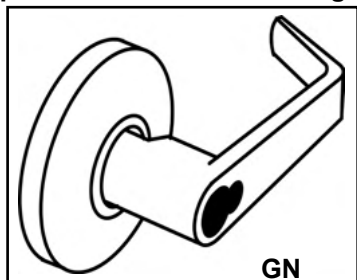

LIFETIME WARRANTY

BHMA CERTIFIED
Be Safe. Be Secure. Look for the Mark.

MEETS
The Buy American Act



STOCK ITEM PRICES IN BOLD.

NON-STOCK FINISHES AND DESIGNS AVAILABLE WITH FACTORY LEAD TIME AND SUBJECT TO MINIMUM ORDER

CORBIN/RUSSWIN (Large Format Interchangeable Core) 7 OR 6 PIN ONLY

FUNCTIONS	ANSI	ITEM#	US26D	US10B	US3	US10	US26	US4	PCS / MC
Entrance	F109	● RUSICCGN00	\$419.00	\$441.00	\$441.00	\$441.00	\$441.00	\$441.00	10
Classroom	F84	● RUSICCGN03	432.00	454.00	454.00	454.00	454.00	454.00	
Communicating (keyed Dbl. cyl.)	F80	● RUSICCGN04	496.00	518.00	518.00	518.00	518.00	518.00	
Storeroom	F86	● RUSICCGN05	419.00	441.00	441.00	441.00	441.00	441.00	
Vestibule	F88	● RUSICCGN06	496.00	518.00	518.00	518.00	518.00	518.00	
Classroom / Intruder	F110	● RUSICCGN07	496.00	518.00	518.00	518.00	518.00	518.00	
Institution (keyed Dbl. cyl.)	F87	● RUSICCGN09	496.00	518.00	518.00	518.00	518.00	518.00	
Dormitory (Non-Clutch)	F90	● RUSICGN101	496.00	519.00	518.00	518.00	518.00	518.00	

SARGENT (Large Format Interchangeable Core) 6 PIN ONLY

FUNCTIONS	ANSI	ITEM#	US26D	US10B	US3	US10	US26	US4	PCS / MC
Entrance	F109	● SARICCGN00	419.00	441.00	441.00	441.00	441.00	441.00	10
Classroom	F84	● SARICCGN03	432.00	454.00	454.00	454.00	454.00	454.00	
Communicating (keyed Dbl. cyl.)	F80	● SARICCGN04	496.00	518.00	518.00	518.00	518.00	518.00	
Storeroom	F86	● SARICCGN05	419.00	441.00	441.00	441.00	441.00	441.00	
Vestibule	F88	● SARICCGN06	496.00	518.00	518.00	518.00	518.00	518.00	
Classroom / Intruder	F110	● SARICCGN07	496.00	518.00	518.00	518.00	518.00	518.00	
Institution (keyed Dbl. cyl.)	F87	● SARICCGN09	496.00	518.00	518.00	518.00	518.00	518.00	
Dormitory (Non-Clutch)	F90	● SARICGN101	496.00	518.00	518.00	518.00	518.00	518.00	

YALE (Large Format Interchangeable Core) 6 PIN ONLY

FUNCTIONS	ANSI	ITEM#	US26D	US10B	US3	US10	US26	US4	PCS / MC
Entrance	F109	● YALICCGN00	419.00	441.00	441.00	441.00	441.00	441.00	10
Classroom	F84	● YALICCGN03	432.00	454.00	454.00	454.00	454.00	454.00	
Communicating (keyed Dbl. cyl.)	F80	● YALICCGN04	496.00	518.00	518.00	518.00	518.00	518.00	
Storeroom	F86	● YALICCGN05	419.00	441.00	441.00	441.00	441.00	441.00	
Vestibule	F88	● YALICCGN06	496.00	518.00	518.00	518.00	518.00	518.00	
Classroom / Intruder	F110	● YALICCGN07	496.00	518.00	518.00	518.00	518.00	518.00	
Institution (keyed Dbl. cyl.)	F87	● YALICCGN09	496.00	518.00	518.00	518.00	518.00	518.00	
Dormitory (Non-Clutch)	F90	● YALICGN101	496.00	518.00	518.00	518.00	518.00	518.00	

● (IC) Indicates function available with Corbin / Ruswin, Sargent, and Yale Full Size Interchangeable Core. Prices do not include cores. For IC Core pricing see page L106. For Keying charges see page L115.

HEAVY DUTY CYLINDRICAL LEVERSETS WITH CLUTCH ANSI - A156.2, SERIES 4000, GRADE 1

● Optional Full Size Interchangeable Core for **SCHLAGE**

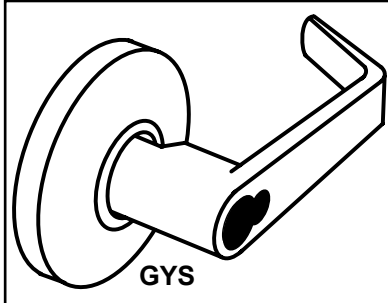

STOCK ITEM PRICES IN BOLD.
NON-STOCK FINISHES AND DESIGNS AVAILABLE WITH FACTORY LEAD TIME AND SUBJECT TO MINIMUM ORDER

SCHLAGE (Large Format Interchangeable Core) **6 PIN ONLY**

FUNCTIONS	ANSI	ITEM#	US26D	US10B	US3	US10	US26	US4	PCS / MC
Entrance	F109	● ICGYS00	\$347.00	\$364.00	\$364.00	364.00	\$364.00	\$364.00	10
Storeroom	F86	● ICGYS05	347.00	364.00	364.00	364.00	364.00	364.00	
Classroom	F84	● ICGYS03	411.00	428.00	428.00	428.00	428.00	428.00	
Communicating (keyed Dbl. cyl.)	F80	● ICGYS04	355.00	375.00	375.00	375.00	375.00	375.00	
Vestibule	F88	● ICGYS06	411.00	428.00	428.00	428.00	428.00	428.00	
Classroom/ Intruder	F110	● ICGYS07	347.00	364.00	364.00	364.00	364.00	364.00	
Institution (keyed Dbl. cyl.)	F87	● ICGYS09	411.00	428.00	428.00	428.00	428.00	428.00	
Dormitory (Non-Clutch)	F90	● ICGYS101	411.00	428.00	428.00	428.00	428.00	428.00	

● (IC) Indicates function available with Schlage Full Size Interchangeable Core. Prices do not include cores.
For IC Core pricing see page L106. For Keying charges see page L115.

► **PACKAGING INCLUDES**

- UL Listed 2 3/4" Backset, 2 1/4" x 1 1/8" faceplate
- Standard "C", 6-pin cylinder
- ASA strike
- **For 2" up to 2 1/4" Thick Door Use Part # below and Add \$343.53 List**

CGN214T00 - Entrance, CGN00	CGN214T05 - Storeroom, CGN05
GN214T02 - Store Lock, GN02	CGN214T09 - Institution, CGN09
CGN214T03 - Classroom, CGN03	CGN214T20 - Privacy, CGN20
CGN214T04 - Communicating, CGN04	GN214T30 - Passage, GN30
● ICCGN214T00 - Entrance, ICCGN00	Available on AT, SPA & TUB Design. Use same Part No.
● ICCGN214T03 - Classroom, ICCGN03	
● ICCGN214T05 - Storeroom, ICCGN05	

► **KEYWAYS**

6-pin solid brass "C" keyway standard. Optional: Schlage E, Schlage C-K, Russwin D1-2-3-4, Corbin 59 / 60, Corbin-Russwin L4, Sargent LA-LB-LC, Falcon / Weiser E, Arrow A, Yale 8, Yale GA and Kwikset. Can also accept Medeco, Assa, Kaba and **Cal-Royal HSK** High Security Cylinders. See **page L115** for keying charges and Cylinder PART #.

► **MOUNT**

1 hole wooden mount
Part # CGNMOUNT **List: \$130.35 Each**

► **ANTI MICROBIAL COATING**

Available on US26D finish only.
Add \$84.00List.
Prefix "ANTB" before Part #.

●► **IC CORE, KEYING CHARGES**

For IC Core pricing see pages **L105-L106**. For Keying charges see page **L115**.

► **TACTILE / LEAD LINING**

- Lead Lining Part # **LEAD**, **Add \$327.00 list**
- Tactile Part # **TAC**, **Add \$66.00 List.**

► **ELECTRIFIED**

Available on Storeroom Only





- Electrified Part # **ELEC**, **Add \$426.00List.**
Specify 12V or 24V, fail safe (SAF) or fail secure (SEC)

STOCK ITEM PRICES IN BOLD.
NON-STOCK FINISHES AVAILABLE WITH FACTORY LEAD TIME
AND SUBJECT TO MINIMUM ORDER

ELECTRIFIED				
DESCRIPTION	ITEM #	US26D	US10B	US4
FAIL SAFE OPTION 12V AC / DC	ECGN0512SAF	\$810.00	\$830.00	\$830.00
	EICGN0512SAF	810.00	830.00	830.00
	EICGYS0512SAF	810.00	830.00	830.00
FAIL SECURE OPTION 12V AC / DC	ECGN0512SEC	810.00	830.00	830.00
	EICGN0512SEC	810.00	830.00	830.00
	EICGYS0512SEC	810.00	830.00	830.00
FAIL SAFE OPTION 24V AC / DC	ECGN0524SAF	810.00	830.00	830.00
	EICGN0524SAF	810.00	830.00	830.00
	EICGYS0524SAF	810.00	830.00	830.00
FAIL SECURE OPTION 24V AC / DC	ECGN0524SEC	810.00	830.00	830.00
	EICGN0524SEC	810.00	830.00	830.00
	EICGYS0524SEC	810.00	830.00	830.00

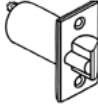
► **ADDITIONAL PARTS & CHARGES FOR GENESYS SERIES**

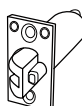
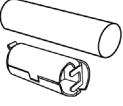
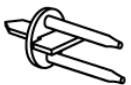
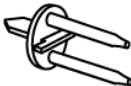
Backsets: UL listed 2 3/8", 2 1/4" x 1" Faceplate, **NO EXTRA CHARGE** if ordered with lock only.
If ordered separately **\$30.00List Each**.

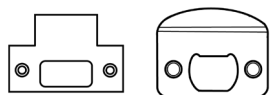
ILLUSTRATION	ITEM #	DESCRIPTION	FINISH	LIST PRICE
	GND238	CGN Series Dead Latch 2 3/8", 2 1/4" x 1" Faceplate	US3, 26D, 10B	\$29.38
	GNS238	CGN Series Spring Latch 2 3/8", 2 1/4" X 1" Faceplate	US3, 26D, 10B	27.70
	GND750	3/4" throw, anti-friction Dead Latch for pairs of fire doors, 2 1/4" x 1 1/8" Faceplate	US3, 26D, 10B, 10	155.00
	GEN5 EXT	5" Backset Extension Link	----	42.00
	GEN334 EXT	3 3/4" Backset Extension Link		
TAIL PIECE				
	ICTP-01	6-pin Tail Piece for IC Genesys Series		4.15
	ICTP-02	7 Pin Tail Piece for IC Genesys Series		4.15
	ICTP-07	Tail Piece for Schlage Large Format IC Core		4.15
EXTRA UL LISTED BACKSET				
	GND234	CGN Series 2 3/4" Dead latch, 2 1/4" x 1 1/8" Faceplate	US3, 26D, 10B	29.38
STRIKES				
	TS	T-Strike	US3, 26D, 10B, 26, 10, 4	5.35
	FLS	Full Lip Strike, Round Corner		

CALYPSO Series *List Price*

EXTRA HEAVY DUTY CYLINDRICAL LEVERSETS

ANSI - A156.2, SERIES 4000, GRADE 1

⊗ Optional Interchangeable Core for Best, Falcon and Arrow

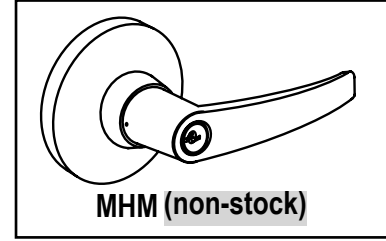
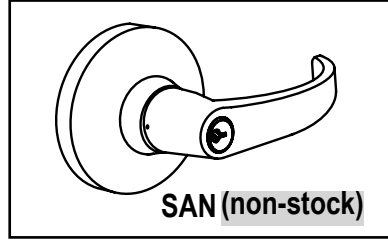
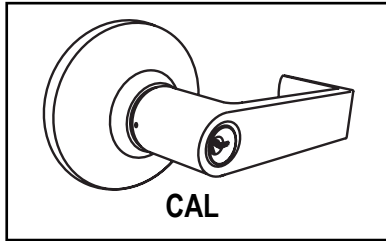

When ordering: "SAN" or "MHM" design **Example:** CAL00 Entrance in "SAN" design is SAN00 or in "MHM" design is MHM00

STOCK ITEM PRICES IN BOLD
NON-STOCK FINISHES AND DESIGNS AVAILABLE WITH FACTORY LEAD TIME AND SUBJECT TO MINIMUM ORDER.
FOR SAN AND MHM DESIGN USE SAME PRICE AS CAL FOR REFERENCE

FUNCTION	ANSI	ITEM #	US26D	US10B, 3, 10, 26, 4	PCS / MC
Entrance	F109	CAL00	\$291.00	\$326.42	6
		⊗ ICCAL00			
Storelock	F91	CAL02	366.36	385.00	
		⊗ ICCAL02			
Classroom	F84	CAL03	299.99	335.80	
		⊗ ICCAL03			
Communicating	F80	CAL04	366.36	385.00	
		⊗ ICCAL04			
Storeroom	F86	CAL05	291.00	326.42	
		⊗ ICCAL05			
Vestibule	F88	CAL06	366.36	385.00	
Classroom Intruder	F110	⊗ ICCAL06			
		CAL07			
		⊗ ICCAL07			
Institution	F87	CAL09			
Dormitory	F90	⊗ ICCAL09			
		CAL101			
Privacy	F76	⊗ ICCAL101	272.00	302.99	
Passage	F75	CAL20	220.50	246.65	
Dummy	----	CAL30	106.50	110.75	12
		CAL40			

⊗ (IC) Indicates function available with **Best, Falcon and Arrow** Interchangeable Core. **Prices do not include cores.**
 For IC Core pricing see pages L105 – L106. For Keying charges see page L115.

► **PACKAGING INCLUDES**

UL Listed 2 3/4" Backset, 2 1/4" x 1 1/8" faceplate, Standard "C", 6-pin cylinder, ASA Strike

► **KEYWAYS**

6-pin solid brass "C" keyway standard. Optional: Schlage E, Schlage C-K, Russwin D1-2-3-4, Corbin 59 / 60, Corbin-Russwin L4, Sargent LA-LB-LC, Falcon / Weiser E, Arrow A, Yale 8, Yale GA and Kwikset. Can also accept Medeco, Assa, Kaba and **Cal-Royal HSK High Security Cylinders**. See **page L115** for keying charges and Cylinder Part #.

► **IC CORE, KEYING CHARGES**

For IC Core pricing see pages **L105-L106**. For Keying charges see page **L115**.

► **ANTI MICROBIAL COATING**

Available on US26D finish only.

Add \$84.00List. Prefix "**ANTB**" before **Part #**.

► **TACTILE / LEAD LINING**

- Lead Lining Part # **LEAD**, Add **\$327.00**
- Tactile Part # **TAC**, Add **\$66.00 List**

► **ADDITIONAL PARTS & CHARGES FOR CALYPSO SERIES**

Backsets: UL listed 2 3/8", 2 1/4" x 1 1/8" faceplate, **NO EXTRA CHARGE** if ordered with lock only. If ordered separately **\$31.40List Each**.

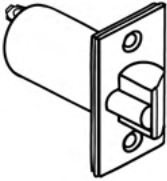
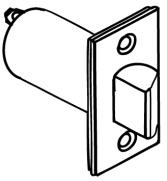
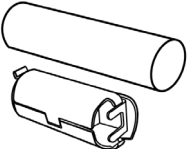
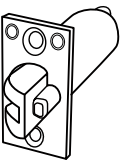
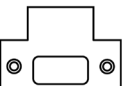
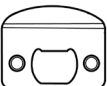
ILLUSTRATION	ITEM #	DESCRIPTION	FINISH	LIST PRICE
EXTRA UL BACKSET				
	CALSLD238	CAL Series Dead latch 2 3/8" 2 1/4" x 1 1/8" Faceplate	US26D	\$31.40
	CALDOR238	CAL101 Dormitory Dead latch 2 3/8" 2 1/4" x 1 1/8" Faceplate	US26D	31.40
	CALSLS238	CAL Series Spring Latch 2 3/8" 2 1/4" x 1 1/8" Faceplate	US26D	31.40
	CALSPL238	CAL Series Privacy Latch 2 3/8" 2 1/4" x 1 1/8" Faceplate	US26D	31.40
	CAL334 EXT	CAL Series 3 3/4" Extension Link To be used with CALSLD238	----	42.00
	CAL5 EXT	CAL Series 5" Extension Link	----	
	CAL750	2 3/4" Backset, 2 1/4" x 1 1/8" faceplate, 3/4" throw, anti-friction Dead latch for pairs of fire doors	US26D	154.15
STRIKES				
	TS	T-Strike	US3, 26D, 10B, 26, 10, 4	5.35
	FLS	Full Lip Strike Round Corner		

OMEGA GRB Series *List Price*

HEAVY DUTY CYLINDRICAL LEVERSETS

ANSI - A156.2, SERIES 4000, GRADE 1

Ⓜ Optional Interchangeable Core for Best, Falcon and Arrow

 <small>3 HOUR FIRE RATED UL10C, UBC7-2-1997</small>	LIFETIME WARRANTY	BHMA™ CERTIFIED <small>Be Safe. Be Secure. Look for the Mark.</small>	MEETS <i>The Buy American Act</i>
--	--------------------------	---	---

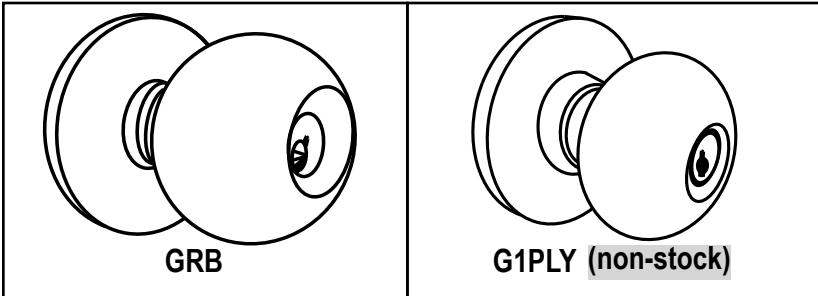

When ordering: "G1PLY" design *Example:* GRB00 Entrance in G1PLY design is G1PLY00

STOCK ITEM PRICES IN BOLD
NON-STOCK FINISHES AND DESIGNS AVAILABLE WITH FACTORY LEAD TIME AND SUBJECT TO MINIMUM ORDER.
FOR G1PLY DESIGN USE SAME PRICE AS GRB FOR REFERENCE

FUNCTION	ANSI	ITEM #	US32D	US3	US10B, 10, 4, 26	PCS / MC
Entrance	F109	Ⓜ GRB00 or ICGRB00	\$264.00	\$264.00	\$282.00	10
Storelock (keyed Dbl. cyl.)	F91	GRB02	353.00	353.00	373.00	
Classroom	F84	Ⓜ GRB03 or ICGRB03	293.00	293.00	311.00	
Communicating (keyed Dbl. cyl.)	F80	GRB04	353.00	353.00	373.00	
Storeroom	F86	Ⓜ GRB05 or ICGRB05	264.00	264.00	282.00	
Institution (keyed Dbl. cyl.)	F87	GRB09	353.00	353.00	373.00	
Privacy	F76	GRB20	235.00	235.00	248.00	
Passage	F75	GRB30	205.85	205.85	219.00	
Single Dummy	----	GRB40	105.54	105.54	116.00	

Ⓜ (IC) Indicates function available with **Best, Falcon and Arrow** Interchangeable Core. **Prices do not include cores.**
 For IC Core pricing see pages L105 – L106. For Keying charges see page L115.

► **PACKAGING INCLUDES**

UL Listed 2 3/4" Backset, 2 1/4" x 1 1/8" faceplate, Standard "C", 6-pin cylinder, ASA Strike

► **KEYWAYS**

6-pin solid brass "C" keyway standard. Optional: Schlage E, Schlage C-K, Russwin D1-2-3-4, Corbin 59 / 60, Corbin-Russwin L4, Sargent LA-LB-LC, Falcon / Weiser E, Arrow A, Yale 8, Yale GA and Kwikset. Can also accept Medeco, Assa, Kaba and **Cal-Royal HSK** High Security Cylinders. See **page L115** for keying charges and Cylinder PART #.

► **IC CORE, KEYING CHARGES**

For IC Core pricing see pages **L105-L106**. For Keying charges see **page L115**.

► **TACTILE / LEAD LINING**

- Lead Lining Part # **LEAD**, Add **\$327.00 list**
- Tactile Part # **TAC**, Add **\$66.00List**

► **ANTI MICROBIAL COATING**

Available on US32D finish only.
Add **\$84.00 List**. Prefix "**ANTB**" before Part #.

► **ELECTRIFIED**

- Electrified Part # **ELEC**, Add **\$426.00 List**
- Specify 12V or 24V, fail safe (EL) or fail secure (EU)

► **ADDITIONAL PARTS & CHARGES FOR OMEGA GRB SERIES**

Backsets: UL listed 2 3/8", 2 1/4" x 1 1/8" faceplate, **NO EXTRA CHARGE** if ordered with lock only.
If ordered separately **\$31.40 List Each**.

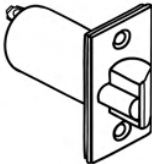
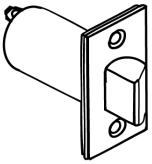
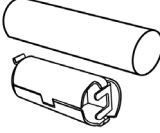
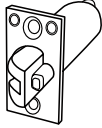
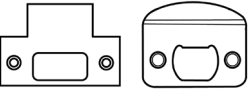
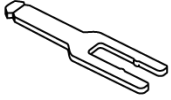
ILLUSTRATION	ITEM #	DESCRIPTION	FINISH	LIST PRICE
EXTRA UL BACKSET				
	CALSLD238	CAL Series Dead latch 2 3/8" 2 1/4" x 1 1/8" Faceplate	US26D	\$31.40
	CALDOR238	CAL101 Dormitory Dead latch 2 3/8" 2 1/4" x 1 1/8" Faceplate	US26D	
	CALSLS238	CAL Series Spring Latch 2 3/8" 2 1/4" x 1 1/8" Faceplate	US26D	
	CALSLP238	CAL Series Privacy Latch 2 3/8" 2 1/4" x 1 1/8" Faceplate	US26D	
	CAL334 EXT	CAL Series 3 3/4" Extension Link To be used with CALSLD238	----	42.00
	CAL5 EXT	CAL Series 5" Extension Link	----	
	CAL750	2 3/4" Backset, 2 1/4" x 1 1/8" faceplate, 3/4" throw, anti-friction Dead latch for pairs of fire doors	US26D	154.15
STRIKES				
	TS	T-Strike	US3, 10B, 26, 10, 4	5.35
	FLS	Full Lip Strike		
TAIL PIECE				
	ICTP-09	Tail Piece for ICGRB	----	4.50



CAL-ROYAL PRODUCTS, INC.
COMPARISON CHART

GENESYS "CGN" AND CALYPSO "CAL" SERIES (GRADE 1 CLUTCH LEVER)

FUNCTION	ANSI #	CAL-ROYAL GENESYS & CALYPSO	SCHLAGE VANDLGARD	SARGENT CLUTCH	RUSSWIN CORBIN	PDQ	FALCON CLUTCH	YALE CLUTCH	HAGER
Entrance	F82 / F109	CGN00, CAL00	ND53 / ND92PD	10G05	CL3351	GT 116 / 182	T501	5407L	3450 / 3453
Storeroom	F86	CGN05, CAL05	ND80 / ND96PD	10G04	CL3357	GT 115	T581	5405L	3480
Classroom	F84	CGN03, CAL03	ND70S / ND94PD	10G37	CL3355	GT 148	T561	5408L	3470
Privacy	F76	CGN20, CAL20	ND40S	10U65	CL3320	GT 176	T301	5402L	3440
Passage	F75	GN30, CAL30	ND10S	10U15	CL3310	GT 126	T101	5401L	3410
Dummy	----	GN40, CAL40	ND170	U94	CL3350	GT 211 / 205	T12	455L	3417
Storelock / Double Cylinder	F91	GN02, CAL02	ND66PD	10G26	CL3382	GT 137	T371	5419L	----
Communication / Double Cylinder	F80	CGN04, CAL04	ND72PD	10G30	CL3362	GT 150	T391	5421L	----
Vestibule	F88	CGN06, CAL06	ND60PD	10G16	CL3372	GT 135	T381	5417L	----
Classroom Intruder	F110	CGN07, CAL07	ND75PD	10G38	CL3352	GT 148	T561	5418L	3495
Institution / Double Cylinder	F87	CGN09, CAL09	ND82PD	10G17	CL3332	GT 128	T411	5430L	----
Exit/Communicating	F89	GN50	ND25D	10G15-3	CL3380	GT 125	----	5428L	----
Dormitory	F90	CAL101	ND73PD	10G54	CL3375	GT 165	T571	5422L	3473

PIONEER "SL" SERIES, EXPLORER "XP" SERIES (GRADE 2 NON-CLUTCH LEVER)
PIONEER "CSL" SERIES (GRADE 2 CLUTCH LEVER)

FUNCTION	ANSI #	CAL-ROYAL PIONEER SERIES	SCHLAGE NON-CLUTCH	SARGENT NON-CLUTCH	RUSSWIN CORBIN	PDQ	FFRNON TUBULAR NON-CLUTCH	YALE	HAGER
Entrance	F82 / F109	CSL00 / SL00	AL53	65G05	CL3851	SP / SK	W511	5307LN	3553
Storeroom	F109	SL01	AL50	----	CL3861	116	W501	---	3550
Classroom	F86	CSL05 / SL05	AL80	65G04	CL3857	115	W581	5305LN	3580
Privacy	F84	CSL03 / SL03	AL70	65G37	CL3855	148	W561	5308LN	3570
Passage	F76	SL30	AL10S	65U15	CL3810	126	W101	5301LN	3510
Dummy	----	40SL40	AL170	65U93	CL3850	211 / 205	W12	5355LN	3517
Exit / Communicating	F89/F111	SL50	AL25	N/A	CL3880	125	W161	5328LN	3525
Exit Communicating Keyed	F112	SL80	----	----	----	----	----	----	----
Patio	F77	SL10	----	----	CL3840	GP182	----	----	----

HIL AND JHIL SERIES (INTERCONNECTED GRADE 2 LEVER)

FUNCTION	ANSI NO	CAL-ROYAL HIL SERES	SCHLAGE	FALCON	HAGER
Entrance - Single Locking	F95	HIL30, JHIL30	CS201	H2101	3710
Entrance - Double Locking	F97	HIL00, JHIL00	-	-	3753

Other functions available upon request and subject to minimum quantity: Storeroom, single / double dummy trim

CAL-ROYAL PRODUCTS, INC.

COMPARISON CHART

GRADE 2 CYLINDRICAL LEVER (SG DESIGN)

FUNCTION	ANSI #	CAL-ROYAL SG SERIES	SCHLAGE S	FALCON "Y" Dane	YALE 4300LN	PDQ SE	CORBIN RUSSWIN	HAGER 3600
Entrance	F82 / F109	SG00	S51PD	Y521	4307LN	SE-116	CL3751	3653
Storeroom	F86	SG05	S80PD	Y581	4305LN	SE-115	CL3759	3680
Classroom	F84	SG03	S70PD	Y561	4308LN	SE-148	CL3755	3670
Patio	F77	SG10	----	----	----	----	----	----
Privacy	F76	SG20	S40D	Y301	4302LN	SE-176	CL3720	3640
Passage	F75	SG30	S10D	Y101	4301LN	SE-126	CL3710	3610
Dummy	----	SG40	S170	Y12	4355LN	SE-211	CL3750	3617
Exit	F89	SG50	----	Y161	----	SE-125	CL3780	----

GRADE 2 CYLINDRICAL LOCKSET, ORBIT STYLE (BA & PLG DESIGNS)

FUNCTION	ANSI #	CAL-ROYAL BA SERIES	SCHLAGE A SERIES	CORBIN 5600	RUSSWIN 3300	SARGENT 6 LINE	YALE 5300	ARROW 151	PDQ SV	FED. NO.
Entrance	F82 / F109	BA00	A53PD	5651	CK4251	6G05	5307	151	SV116	160A
Privacy	F76-2	BA20	A40S	5620	CK4220	6U65	----	157	SV176	160L
Passage	F75-2	BA30	A10S	5610	CK4210	6U15	5301	156	SV126	160N
Storeroom	F86-2	BA05	A80PD	5657	CK4257	6G04	5305	151F	SV115	160D
Classroom	F84-2	BA03	A70PD	5655	CK4255	6G37	5308	151S	SV148	160R
Double Cyl	----	BA04	A66D	----	CK4262	----	5316	----	SV137	----
Sgl Dummy	F79-2	BA40	A170	½ DT	CK4250	6U93	355	125	SV211	----
Storage	F91	BA02	----	----	CK4282	----	----	----	----	----
Institution	F87	BA09	----	----	CK4232	----	----	----	----	----
Exit	F89	BA50	A25D	----	----	6G15-3	5328	156CB	SV125	----

TUSCANY Series *List Price*

Clutch Mechanism, Optional Thru Bolt Installation
ANSI - A156.2, Series 4000, Grade 2

Ⓢ Optional Interchangeable Core for **Best, Falcon and Arrow**

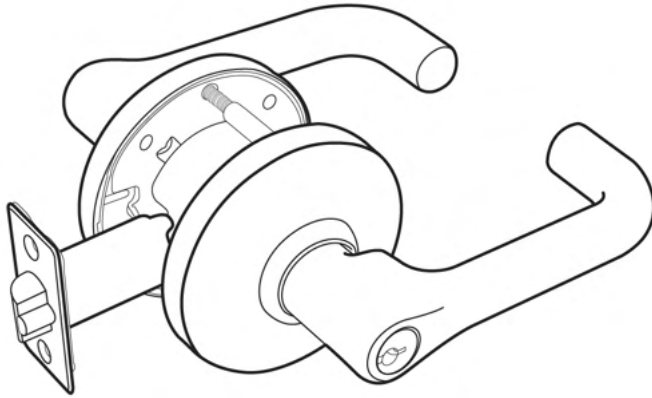

MEETS
The Buy American Act



STOCK ITEM PRICES IN BOLD
NON-STOCK FINISHES AND DESIGNS AVAILABLE WITH FACTORY LEAD TIME AND SUBJECT TO MINIMUM ORDER.

FUNCTIONS	ANSI	ITEM #	US26D	US10B	US3	US10	US26	US4	PCS / MC
Entrance	F109	CTUSL00	\$226.00	\$232.60	\$226.00	\$232.00	\$232.00	\$232.00	10
		ⓈICCTUSL00	226.00	232..60	226.00	232.00	232.00	232.00	
Entrance Push Button Lock	F82	CTUSL01	226.00	232.60	226.00	232.00	232.00	232.00	
Classroom	F84	CTUSL03	226.00	232.60	226.00	232.00	232.00	232.00	
		ⓈICCTUSL03	226.00	232.60	226.00	232.00	232.00	232.00	
Storeroom	F86	CTUSL05	226.00	232.60	226.00	232.00	232.00	232.00	
		ⓈICCTUSL05	226.00	232.60	226.00	232.00	232.00	232.00	
Privacy	F76	CTUSL20	193.00	202.00	193.00	202.00	202.00	202.00	
Passage	F75	TUSL30	168.00	179.00	168.00	179.00	179.00	179.00	
Exit	F89	TUSL50	171.00	186.00	171.00	186.00	186.00	186.00	
Single Dummy	----	TUSL40	73.00	80.00	73.00	80.00	80.00	80.00	20

Ⓢ (IC) Indicates function available with **Best, Falcon and Arrow** Interchangeable Core. **Prices do not include cores.**
For IC Core pricing see pages **L105 – L106**. For Keying charges see page **L115**.

► **ADDITIONAL PARTS & CHARGES TUSCANY SERIES**

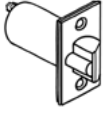
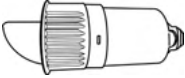
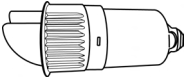
Backsets: UL listed 2 3/8", (2 1/4" x 1") faceplate, **NO EXTRA CHARGE** if ordered with lock only.
Otherwise \$12.15 List Each.

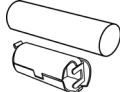
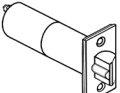
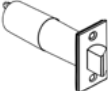
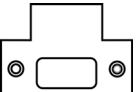
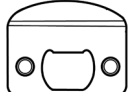
ILLUSTRATION	ITEM #	DESCRIPTION	FINISH	LIST PRICE
	ULSLD238	SL Series UL-listed Dead Latch 2 3/8" 2 1/4" x 1" Faceplate	US3, 26D, 10B, 10, 26	\$30.00
	ULSLS238	SL Series UL-listed Spring Latch 2 3/8" 2 1/4" x 1" Faceplate	US26D, 10B, 10, 26	
	SLDRI-1	2 3/4" Entrance, Drive-in Latch bolt for G2 Lockset	ZINC	
	SLDRI-2	2 3/4" Privacy / Passage, Drive-in Latch bolt for G2 Lockset		
	SLDRI-4	2 3/8" Entrance, Drive-in Latch bolt for G2 Lockset		
	SLDRI-5	2 3/8" Privacy / Passage, Drive-in Latch bolt for G2 Lockset		
EXTRA UL LISTED BACKSET				
	ULSLD234	SL Series Dead Latch 2 3/4" 2 1/4" x 1 1/8" Faceplate	US3, 26D, 10B, 10, 26	30.00
	ULSLS234	SL Series Spring Latch 2 3/4" 2 1/4" x 1 1/8" Faceplate	US3, 26D, 10B, 10, 26	
3 3/4", 5" UL LISTED BACKSET				
	SL5	5" UL listed Extension Link	---	42.00
	SLD334	3 3/4" Dead latch, 2 1/4" x 1 1/8" Faceplate	US3, 26D, 10B	
	SLS334	3 3/4" Spring Latch, 2 1/4" x 1 1/8" Faceplate	US3, 26D, 10B	
STRIKES				
	TS	T-Strike	US3, 26D, 10B, 10, 26, 15, 4	5.35
	FLS	Full lip strike	US3, 26D, 10B, 10, 26, 15, 4, 5	

CRCODE200 Series *List Price*

**GRADE 2, MECHANICAL STAND ALONE PUSH BUTTON LOCK
AND EXIT DEVICE TRIM WITH **BREAKAWAY LEVER FEATURE****

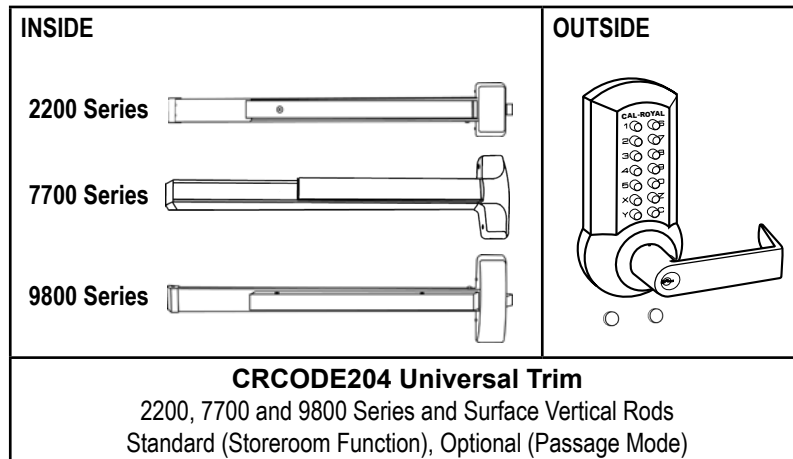
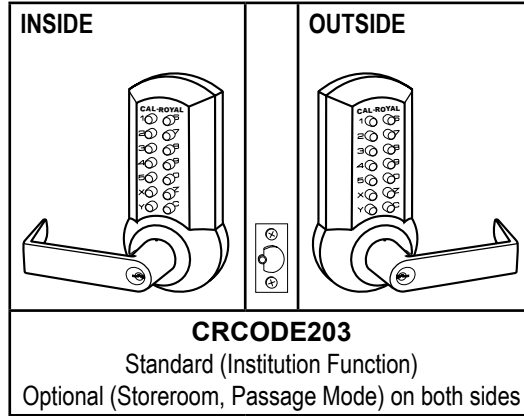
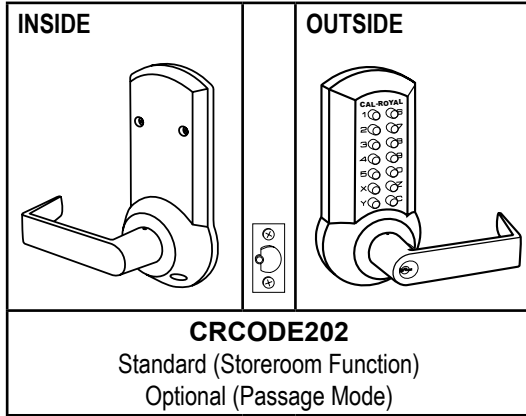

FUNCTION	ITEM #	US26D	US10B	PCS / MC
Mechanical Easy Code Change Lock with 2 3/4" backset latchbolt Door Thickness: 1 3/8" - 2 1/4"	CRCODE202	\$753.00	791.00	8
Double Coded Easy Code Change Lock with 2 3/4" backset latchbolt Door Thickness: 1 3/8" - 1 3/4"	CRCODE203	1019.00	1070.00	8
Mechanical Easy Code Change Exit Trim for 2200, 7000 and 9800 Series Exit Device Door Thickness: 1 3/4" - 2"	CRCODE204	653.00	687.00	8
ACCESSORIES				
CRCODE200 Series Dead latch 2 3/8" 2 1/4" x 1" Faceplate (for CRCODE-202 and 203)	CRSLD	45.00	---	1
Easy Code Change Key	EZCHKEY	BLUE 3.00	---	1

► For Keying charges see page L115.

PIONEER SL Series *List Price*

HEAVY DUTY CYLINDRICAL LEVERSETS

ANSI - A156.2, Series 4000, Grade 2

Optional Interchangeable Core for **Best, Falcon and Arrow**

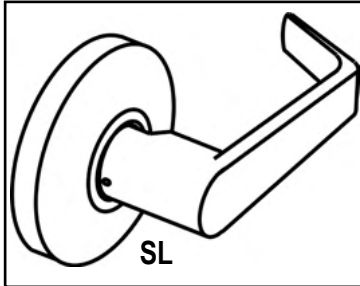

 3 HOUR FIRE RATED UL10C, UBC7-2-1997	LIFETIME WARRANTY	BHMA CERTIFIED Be Safe. Be Secure. Look for the Mark.	MEETS <i>The Buy American Act</i>
---	--------------------------	--	---



STOCK ITEM PRICES IN BOLD

NON-STOCK FINISHES AND DESIGNS AVAILABLE WITH FACTORY LEAD TIME AND SUBJECT TO MINIMUM ORDER.

FUNCTIONS	ANSI	ITEM #	US26D	US3	US10BE, 10, 26, 4, 15, 5	US1	PCS / MC
Entrance	F109	SL00 ● IC SL00	\$191.00	\$191.00	\$198.00	\$198.00	10
Combination Entrance and Single Cylinder Deadbolt -- KA/2 packed together	NEW ITEM	SL00 / T220	254.00	---	---	---	
Storeroom	F91	SL05 ● IC SL05	191.00	191.00	198.00	198.00	
Classroom	F84	SL03 ● IC SL03	191.00	191.00	198.00	198.00	
Entrance Push Button Lock	F82	SL01	191.00	191.00	198.00	198.00	
		● IC SL01	191.00	191.00	198.00	198.00	
Exit Lock / Connecting Room with key	----	SL80	191.00	191.00	198.00	198.00	
		● IC SL80	191.00	191.00	198.00	198.00	
Dormitory / Assisted Living	F90	SL101	204.00	204.00	204.00	204.00	
		● IC SL101	204.00				
Privacy (see below for split finishes)	F76	SL20	158.00	158.00	167.00	167.00	
Patio	F77	SL10	157.00	157.00	167.00	167.00	
Passage	F75	SL30	153.00	153.00	161.00	161.00	
Exit	F89	SL50	154.00	154.00	167.00	167.00	
Single Dummy	----	SL40	53.00	53.00	59.00	59.00	20

● (IC) Indicates function available with **Best, Falcon and Arrow** Interchangeable Core. Prices do not include cores. For IC Core pricing see pages L105 – L106. For Keying charges see page L115.

► **SPLIT FINISHES FOR PRIVACY FUNCTION**

ILLUSTRATION	ITEM #	FUNCTIONS	ANSI	LIST PRICE	PCS / MC	UNIT
 SL20	SL20 US3 / 26 (Inside)	Privacy	F76	183.00	10	Ea.
	SL20 US10B / 26 (Inside)					
	SL20 US4 / 26D (Inside)					
	SL20 US4 / 26 (Inside)					
	SL20 US4 / 3 (Inside)					
	SL20 US3 / 26D (Inside)					
	SL20 US10B / 26D (Inside)					

PIONEER RL & AG Series *List Price* HEAVY DUTY CYLINDRICAL LEVERSETS

ANSI - A156.2, Series 4000, Grade 2

Optional Interchangeable Core for Best, Falcon and Arrow

	LIFETIME WARRANTY	BHMA™ CERTIFIED Be Safe. Be Secure. Look for the Mark.	MEETS <i>The Buy American Act</i>
--	--------------------------	--	---

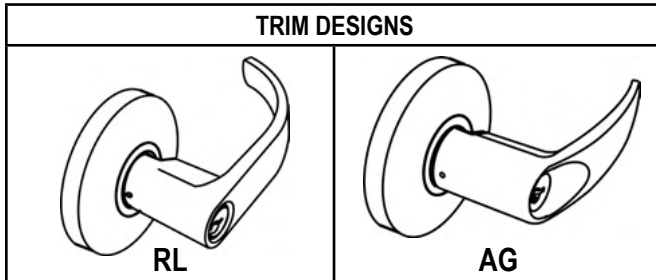

STOCK ITEM PRICES IN BOLD
NON-STOCK FINISHES AND DESIGNS AVAILABLE WITH FACTORY LEAD TIME AND SUBJECT TO MINIMUM ORDER.

FUNCTIONS	ANSI	ITEM #		US26D	US3	US10BE, 10, 26, 4, 15	US1	PCS / MC	
Entrance	F109	RL00	AG00	\$202.00	\$202.00	\$209.00	\$209.00	10	
		ICRL00	ICAG00		202.00	209.00	209.00		
Storeroom	F91	RL05	AG05		202.00	209.00	209.00		
		ICRL05	ICAG05		202.00	209.00	209.00		
Classroom	F84	RL03	AG03		202.00	209.00	209.00		
		ICRL03	ICAG03		202.00	209.00	209.00		
Entrance Push Button Lock	F82	RL01	AG01		202.00	202.00	209.00		209.00
		ICRL01	ICAG01		202.00	202.00	209.00		209.00
Exit Lock / Connecting Room with key	---	RL80	AG80		202.00	202.00	209.00		209.00
		ICRL80	ICAG80		202.00	202.00	209.00		209.00
Dormitory / Assisted Living	F90	RL101	AG101	216.00	216.00	223.00	223.00		
		ICRL101	ICAG101	216.00	216.00				
Privacy (see below for split finishes)	F76	RL20	AG20	170.00	170.00	179.00	179.00		
Patio	F77	RL10	AG10	166.00	166.00				
Passage	F75	RL30	AG30	165.00	165.00	173.00	173.00		
Exit	F89	RL50	AG50	166.00	166.00	179.50	179.50		
Single Dummy	---	RL40	AG40	65.00	65.00	70.40	70.40	20	

(IC) Indicates function available with **Best, Falcon and Arrow** Interchangeable Core. Prices do not include cores.
For IC Core pricing see pages **L105 – L106**. For Keying charges see page **L115**.

► SPLIT FINISHES FOR PRIVACY FUNCTION

ILLUSTRATION	ITEM #	FUNCTIONS	ANSI	LIST PRICE	PCS / MC	UNIT
<p style="text-align: center;">RL20</p>	RL20 or AG20 US3 / 26 (Inside)	Privacy	F76	183.00	10	Ea.
	RL20 or AG20 US10B / 26 (Inside)					
	RL20 or AG20 US4 / 26D (Inside)					
	RL20 or AG20 US4 / 26 (Inside)					
	RL20 or AG20 US4 / 3 (Inside)					
	RL20 or AG20 US3 / 26D (Inside)					
	RL20 or AG20 US10B / 26D (Inside)					

PIONEER CSL, CRL & CAG CLUTCH HEAVY DUTY CYLINDRICAL LEVERSETS WITH CLUTCH ANSI - A156.2, Series 4000, Grade 2

Optional Interchangeable Core for **Best, Falcon and Arrow**



LIFETIME WARRANTY

BHMA CERTIFIED
Be Safe. Be Secure. Look for the Mark.

MEETS
The Buy American Act

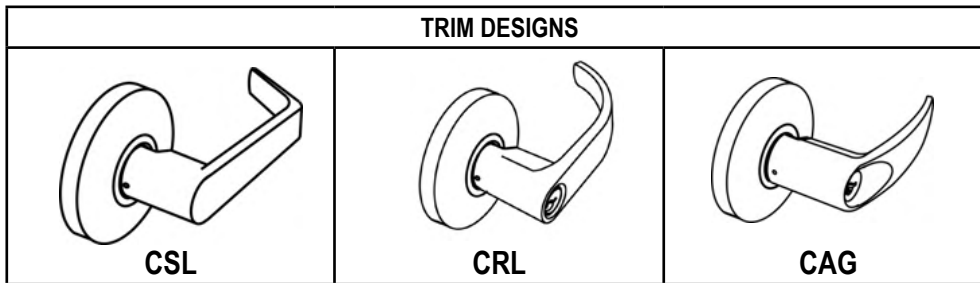

STOCK ITEM PRICES IN BOLD
NON-STOCK FINISHES AND DESIGNS AVAILABLE WITH FACTORY LEAD TIME
AND SUBJECT TO MINIMUM ORDER.

FUNCTIONS	ANSI	ITEM #	US26D	US3	US10BE	US10, 26, 4, 15, 5	PCS / MC
Entrance	F109	CSL00	\$214.00	\$214.00	\$221.00	\$221.00	10
		● ICCSL00		214.00	221.00		
Storeroom	F91	CSL05	214.00	214.00	221.00		
		● ICCSL05	214.00	214.00	221.00		
Classroom	F84	CSL03	214.00	214.00	221.00		
		● ICCSL03	214.00	214.00	221.00		
Privacy	F76	CSL20	182.00	182.00	191.00	191.00	

FUNCTIONS	ANSI	ITEM #		US26D, 3	US10BE, 10, 26, 4, 15, 5	PCS / MC
Entrance	F109	CRL00	CAG00	\$214.00	\$221.00	10
		● ICCRL00	● ICCAG00	214.00	221.00	
Storeroom	F91	CRL05	CAG05	214.00	221.00	
		● ICCRL05	● ICCAG05	214.00	221.00	
Classroom	F84	CRL03	CAG03	214.00	221.00	
		● ICCRL03	● ICCAG03	214.00	221.00	
Privacy	F76	CRL20	CAG20	182.00	191.00	

● (IC) Indicates function available with **Best, Falcon and Arrow** Interchangeable Core. Prices do not include cores. For IC Core pricing see pages L105 – L106. For Keying charges see page L115.

► **PACKAGING INCLUDES**

UL Listed 2 3/4" Backset, 2 1/4" x 1 1/8" faceplate ASA Strike

► **KEYWAYS**

6-pin solid brass "C" keyway standard. Optional: Schlage E, Schlage C-K, Russwin D1-2-3-4, Corbin 59 / 60, Arrow A, Corbin-Russwin L4, Sargent LA-LB-LC, Falcon / Weiser E, Yale 8, Yale GA and Kwikset. Can also accept Medeco, Assa, Kaba and **Cal-Royal HSK** High Security Cylinders. See page L115 for keying charges and Cylinder PART #.

► **IC CORES, KEYING CHARGES**







For IC Core pricing see pages L105 - L106. For Keying charges see page L115.

► **TACTILE / LEAD LINING**

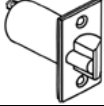
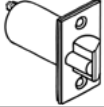
Lead Lining Part # **LEAD** Add \$327.00 List
Tactile Part # **TAC** Add \$66.00 List

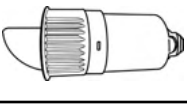
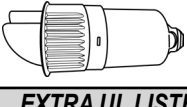
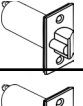
► **ADDITIONAL PARTS & CHARGES FOR PIONEER SERIES**

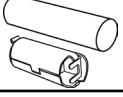
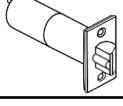
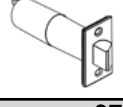
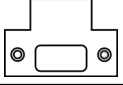
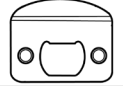
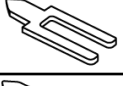
Backsets: UL listed 2 3/8", (2 1/4" x 1") faceplate, **NO EXTRA CHARGE** if ordered with lock only. Otherwise **\$28.23 List Each**.

ILLUSTRATION	ITEM #	DESCRIPTION	FINISH	LIST PRICE
	ULSLD238	SL Series UL-listed Dead Latch 2 3/8" 2 1/4" x 1" Faceplate	US3, 26D, 10B, 10, 26	\$30.00
	ULSLS238	SL Series UL-listed Spring Latch 2 3/8" 2 1/4" x 1" Faceplate	US26D, 10B, 10, 26	
	ULSGPA238	2 3/8" UL-listed Dead Latch, 2 1/4" x 1" Faceplate (for SG10, SL10 Patio Function and SL101 Dormitory/Assisted Living Function)	US26D	
	SLDRI-1	2 3/4" Entrance, Drive-in Latch bolt for G2 Lockset	ZINC	
	SLDRI-2	2 3/4" Privacy / Passage, Drive-in Latch bolt for G2 Lockset		
	SLDRI-4	2 3/8" Entrance, Drive-in Latch bolt for G2 Lockset		
	SLDRI-5	2 3/8" Privacy / Passage, Drive-in Latch bolt for G2 Lockset		
EXTRA UL LISTED BACKSET				
	ULSLD234	SL Series Dead Latch 2 3/4" 2 1/4" x 1 1/8" Faceplate	US3, 26D, 10B, 10, 26	30.00
	ULSLS234	SL Series Spring Latch 2 3/4" 2 1/4" x 1 1/8" Faceplate	US3, 26D, 10B, 10, 26	
3 3/4", 5" UL LISTED BACKSET				
	SL5	5" UL listed Extension Link	----	42.00
	SLD334	3 3/4" Dead latch, 2 1/4" x 1 1/8" Faceplate	US3, 26D, 10B	
	SLS334	3 3/4" Spring Latch, 2 1/4" x 1 1/8" Faceplate	US3, 26D, 10B	
STRIKES				
	TS	T-Strike	US3, 26D, 10B, 10, 26, 15, 4	5.35
	FLS	Full lip strike	US3, 26D, 10B, 10, 26, 15, 4, 5	
TAIL PIECE				
	ICTP-03	6-pin Tail Piece for IC Pioneer Series	----	4.50
	ICTP-04	7 Pin Tail Piece for IC Pioneer Series	----	4.50

COMMANDER COM (CLUTCH) Series

HEAVY DUTY CYLINDRICAL LEVERSETS WITH CLUTCH

ANSI - A156.2, Series 4000, Grade 2

With Interchangeable Core to accept **Schlage Full Size** format
OEM Interchangeable Core Cylinder

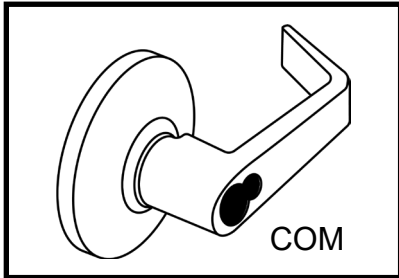

LIFETIME WARRANTY

MEETS
The Buy American Act

STOCK ITEM PRICES IN BOLD

NON-STOCK FINISHES AND DESIGNS AVAILABLE WITH FACTORY LEAD TIME AND SUBJECT TO MINIMUM ORDER.

FUNCTIONS	ANSI	ITEM #	US26D, 3	US10B	US10, 26, 4, 5	PCS / MC
Entrance	F109	ICCOM00	\$234.00	\$234.00	\$234.00	10
Storeroom	F86	ICCOM05				
Classroom	F84	ICCOM03	239.00	246.00	246.00	

***Use SL Pioneer series lockset for interior locks. Prices do not include cores. For IC Core pricing see page L106. For Keying charges see page L115.

► **PACKAGING INCLUDES**

- UL Listed 2 3/4" Backset, 2 1/4" x 1 1/8" faceplate
- Less cylinder
- ASA Strike

► **TACTILE / LEAD LINING**

- Lead Lining Part # LEAD Add \$327.00 List
- Tactile Part # TAC Add \$66.00 List

► **ADDITIONAL PARTS & CHARGES**

Backsets: UL listed 2 3/4", 2 1/4" x 1 1/8" Faceplate, **NO EXTRA CHARGE** if ordered with lock only. If ordered separately **\$29.39 List Each**.

ILLUSTRATION	ITEM #	DESCRIPTION	FINISH	LIST PRICE
	GND238	CGN Series UL-listed Dead Latch 2 3/8"	US3, 26D, 10B, 26	\$30.00
	GND750	2 3/4" x 1 1/8" x 3/4" throw, anti-friction Dead latch for pairs of fire doors	US3, 26D, 10B, 10	154.15
	SLDRI-1	2 3/4" Entrance, Drive-in Latch bolt for G2 Lockset	ZINC	30.00
	SLDRI-4	2 3/8" Entrance, Drive-in Latch bolt for G2 Lockset	ZINC	
♦ EXTRA UL LISTED BACKSET				
	GND234	CGN Series Dead Latch 2 3/4"	US3, 26D, 10B, 26	30.00
	GEN5 EXT	5" Backset Extension Link	----	42.00
GEN334 EXT	3 3/4" Backset Extension Link			
STRIKES				
	TS	T-Strike	US3, 26D, 10B, 26, 10, 4	5.35
	FLS	Full lip strike	US3, 26D, 10B, 26, 10, 4, 5	
TAIL PIECE				
	ICTP07	Tail piece for Schlage Large format IC Core	----	4.50

EXPLORER XP Series List Price

HEAVY DUTY CYLINDRICAL LEVERSETS

ANSI - A156.2, Series 4000, Grade 2

Optional Interchangeable Core for **Best, Falcon and Arrow**

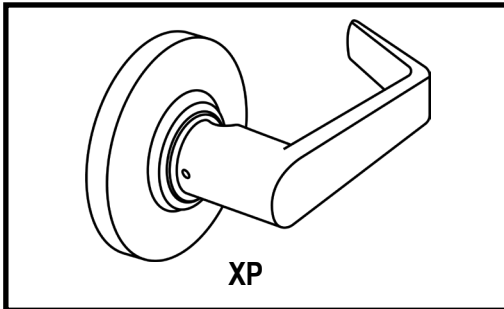

STOCK ITEM PRICES IN BOLD
NON-STOCK FINISHES AND DESIGNS AVAILABLE WITH FACTORY LEAD TIME
AND SUBJECT TO MINIMUM ORDER.

ANSI	FUNCTIONS	ITEM #	US26D	US3	US10B, 10, 26, 4	US5,15	PCS / MC
F109	Entrance	XP00	\$179.00	\$190.00	\$198.00	\$198.00	10
		⚙️ ICXP00		190.00	198.00		
F91	Storeroom	XP05		190.00	198.00		
		⚙️ ICXP05		190.00	198.00		
F84	Classroom	XP03		190.00	198.00		
		⚙️ ICXP03		190.00	198.00		
F76	Privacy (See below for split finishes)	XP20	149.00	158.00	167.00	167.00	
---	Hospital Privacy	HXP20	183.00	189.00	199.00	199.00	
F75	Passage	XP30	143.20	153.00	161.00	161.00	
F89	Exit	XP50	154.00	154.00	168.00	168.00	
----	Single Dummy	XP40	53.25	53.25	59.00	59.00	20

⚙️ (IC) Indicates function available with **Best, Falcon and Arrow** Interchangeable Core. Prices do not include cores.
For IC Core pricing see pages L105 – L106. For Keying charges see page L115.

◆ **SPLIT FINISHES FOR PRIVACY FUNCTION**

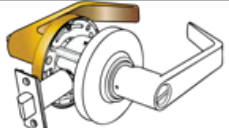
ILLUSTRATION	ITEM #	FUNCTIONS	ANSI	FINISH	LIST PRICE	PCS / MC
	XP20	Privacy	F76	US3 / 26D (Inside)	\$184.00	10
				US4 / 26 (Inside)		
				US10B / 26 (Inside)		
				US4 / 26D (Inside)		

EXPLORER XPRL Series List Price

HEAVY DUTY CYLINDRICAL LEVERSETS

ANSI - A156.2, SERIES 4000, GRADE 2

Optional Interchangeable Core for **Best, Falcon and Arrow**

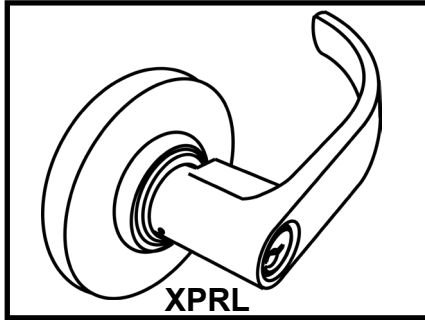

LIFETIME WARRANTY

BHMA CERTIFIED
Be Safe. Be Secure. Look for the Mark.

MEETS
The Buy American Act



STOCK ITEM PRICES IN BOLD
NON-STOCK FINISHES AND DESIGNS AVAILABLE WITH FACTORY LEAD TIME
AND SUBJECT TO MINIMUM ORDER.

FUNCTIONS	ANSI	ITEM #	US26D	US10B	US3	US10,4 26,15	PCS / MC		
Entrance	F109	XPRL00	\$186.00	\$202.00	\$202.00	\$198.00	10		
		⚙️ ICXPRL00	198.00	202.00					
Storeroom	F91	XPRL05	186.00	202.00					
		⚙️ ICXPRL05	198.00	202.00					
Classroom	F84	XPRL03	186.00	202.00					
		⚙️ ICXPRL03	198.00	202.00					
Privacy (See below for split finishes)	F76	XPRL20	160.00	179.00				170.00	179.00
Hospital Privacy	---	HXPRL20	197.00	203.00				198.00	203.00
Passage	F75	XPRL30	154.00	173.00				164.00	173.00
Exit	F89	XPRL50	166.00	180.00	166.00	180.00			
Single Dummy	----	XPRL40	65.00	70.00	65.00	70.00	20		

⚙️ (IC) Indicates function available with **Best, Falcon and Arrow** Interchangeable Core. Prices do not include cores.
For IC Core pricing see pages L105 – L106. For Keying charges see page L115.

◆ **SPLIT FINISHES FOR PRIVACY FUNCTION**

ILLUSTRATION	ITEM #	FUNCTIONS	ANSI	FINISH	LIST PRICE	PCS / MC
	XPRL20	Privacy	F76	US3 / 26D (Inside)	\$195.00	10
				US4 / 26 (Inside)		
				US10B / 26 (Inside)		
				US4 / 26D (Inside)		

EXPLORER CXP, CXPRL CLUTCH

HEAVY DUTY CYLINDRICAL LEVERSETS WITH CLUTCH

ANSI - A156.2, Series 4000, Grade 2

Optional Interchangeable Core for **Best, Falcon and Arrow**

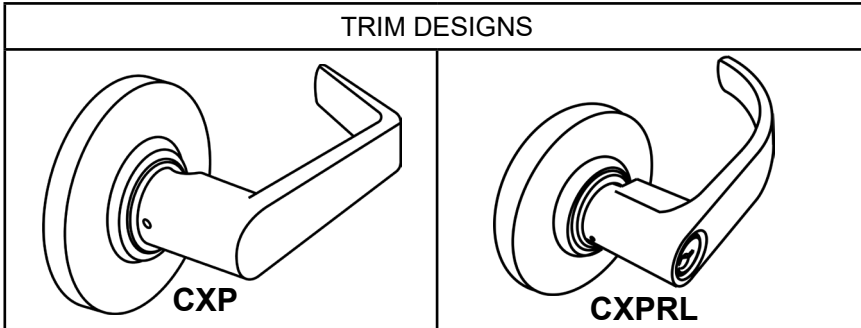

MEETS
The Buy American Act

STOCK ITEM PRICES IN BOLD
NON-STOCK FINISHES AND DESIGNS AVAILABLE WITH FACTORY LEAD TIME
AND SUBJECT TO MINIMUM ORDER.

FUNCTIONS	ANSI	ITEM #	US26D	US10B	US3	US10, 26, 4, 15, 5	PCS / MC
Entrance	F109	CXP00	\$214.00	\$221.00	\$214.00	\$221.00	10
		⌘ ICCXP00	214.00	221.00	214.00		
Storeroom	F91	CXP05	214.00	221.00	214.00		
		⌘ ICCXP05	214.00	221.00	214.00		
Classroom	F84	CXP03	214.00	221.00	214.00		
		⌘ ICCXP03	214.00	221.00	214.00		
Privacy	F76	CXP20	182.00	191.00	182.00	191.00	
Hospital Privacy	---	HCXP20	206.00	215.00	206.00	215.00	

FUNCTIONS	ANSI	ITEM #	US26D	US10B	US3	US10, 26, 4, 15, 5	PCS / MC
Entrance	F109	CXPRL00	\$214.00	\$221.00	\$214.00	\$221.00	10
		⌘ ICCXPRL00	214.00	221.00	214.00		
Storeroom	F91	CXPRL05	214.00	221.00	214.00		
		⌘ ICCXPRL05	214.00	221.00	214.00		
Classroom	F84	CXPRL03	214.00	221.00	214.00		
		⌘ ICCXPRL03	214.00	221.00	214.00		
Privacy	F76	CXPRL20	182.00	191.00	182.00	191.00	
Hospital Privacy	---	HCXPRL20	206.00	215.00	206.00	215.00	

⌘ (IC) Indicates function available with **Best, Falcon and Arrow** Interchangeable Core. **Prices do not include cores.**
For IC Core pricing see pages **L105 – L106**. For Keying charges see page **L115**.

► **PACKAGING INCLUDES**

- UL Listed 2 3/4" Backset with 2 1/4" x 1" Faceplate, Square corner, packed with 1/8" Filler for 1 1/8" width
- Standard "C", 6-pin cylinder
- ASA Strike

► **TACTILE / LEAD LINING**

Lead Lining Part # **LEAD Add \$ 327.00**List
Tactile Part # **TAC Add \$66.00** List

► **MOUNT**

2 hole wooden mount
Part # **SLMOUNT**
List: **\$163.00**Each

► **IC CORES, KEYING CHARGES**



For IC Core pricing see pages **L105 – L106**. For Keying charges see page **L115**.

► **KEYWAYS**

6-pin solid brass "C" keyway standard. Optional: Schlage E, Schlage C-K, Russwin D1-2-3-4, Corbin 59 / 60, Corbin-Russwin L4, Sargent LA-LB-LC, Falcon / Weiser E, Arrow A, Yale 8, Yale GA and Kwikset. Can also accept Medeco, Assa, Kaba and **Cal-Royal HSK** High Security Cylinders. See **page L115** for keying charges and Cylinder PART #.

► **ADDITIONAL PARTS & CHARGES FOR EXPLORER SERIES**

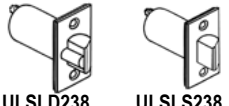
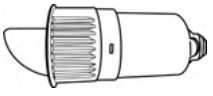
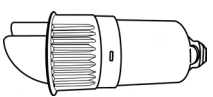
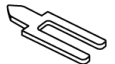
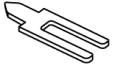
Backsets: UL listed 2 3/8", (2 1/4" x 1") faceplate, **NO EXTRA CHARGE** if ordered with lock only. Otherwise **\$30.00 List Each**.

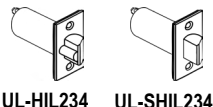
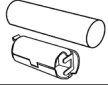
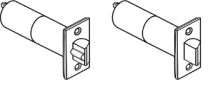
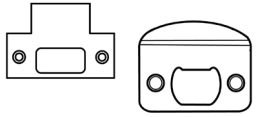
ILLUSTRATION	ITEM#	DESCRIPTION	FINISH	LIST PRICE
 ULSLD238 ULSLS238	ULSLD238	XP Series UL-listed Dead Latch 2 3/8" 2 1/4" x 1" Faceplate	US3, 26D, 10B, 10, 26	\$30.00
	ULSLS238	XP Series UL-listed Spring Latch 2 3/8" 2 1/4" x 1" Faceplate	US3, 26D, 10B, 10, 26	
	SLDRI-1	2 3/4" Entrance, Drive-in Latch bolt for G2 Lockset	ZINC	
	SLDRI-2	2 3/4" Privacy / Passage, Drive-in Latch bolt for G2 Lockset		
	SLDRI-4	2 3/8" Entrance, Drive-in Latch bolt for G2 Lockset		
	SLDRI-5	2 3/8" Privacy / Passage, Drive-in Latch bolt for G2 Lockset		
TAIL PRICE				
	ICTP-03	6-pin Tail Piece for IC Explorer Series	----	4.50
	ICTP-04	7 Pin Tail Piece for IC Explorer Series		4.50
	ICTP-05	6-pin Tail Piece for ICXP03 Explorer Series Classroom Function Only		4.50
	ICTP-06	7 Pin Tail Piece for ICXP03 Explorer Series Classroom Function Only		4.50
EXTRA UL LISTED BACKSET				
 UL-HIL234 UL-SHIL234	UL-HIL234	XP Series Dead Latch 2 3/4" 2 1/4" x 1 1/8" Faceplate	US3, 26D, 10B, 10, 26	30.00
	UL-SHIL234	XP Series Spring Latch 2 3/4" 2 1/4" x 1" Faceplate	US3, 26D, 10B, 10, 26	
3 3/4", 5" UL LISTED BACKSET				
	SL5	5" UL listed Extension Link	----	42.00
	SLD334	3 3/4" Dead latch, 2 1/4" x 1 1/8" Faceplate	US3, 26D, 10B	
	SLS334	3 3/4" Spring Latch, 2 1/4" x 1 1/8" Faceplate	US3, 26D, 10B	
STRIKES				
	TS	T-Strike	US3, 4, 26D, 26 10B, 10, 15	5.35
	FLS	Full lip strike	US3, 4, 26D, 10B, 10, 15, 26, 5	

CHALLENGER Series List Price

STANDARD DUTY CYLINDRICAL LEVERSETS

ANSI STANDARD A156.2, GRADE 2

Ⓢ Optional Interchangeable Core for **Best, Falcon and Arrow**

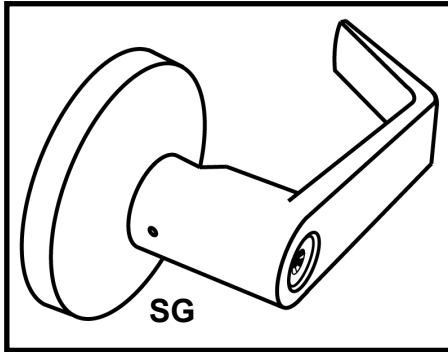

STOCK ITEM PRICES IN BOLD
NON-STOCK FINISHES AND DESIGNS AVAILABLE WITH FACTORY LEAD TIME
AND SUBJECT TO MINIMUM ORDER.

FUNCTIONS	ANSI	ITEM #	US26D	US3	US10B, 26	US15	US10, 4, 15A	PCS / MC	
Entrance	F109	SG00	\$145.00	\$145.00	\$158.00	\$158.00	\$158.00	10	
		Ⓢ ICSG00	145.00	145.00	158.00	158.00			
Entrance Push Button Lock	F82	SG01	145.00	---	---	---			
Storeroom	F91	SG05	145.00	145.00	158.00	158.00			
		Ⓢ ICSG05	145.00	145.00	158.00	158.00			
Classroom	F84	SG03	145.00	145.00	158.00	158.00			
		Ⓢ ICSG03	145.00	145.00	158.00	158.00			
Patio	F77	SG10	129.00	129.00	142.00	142.00			142.00
Privacy	F76	SG20	119.00	119.00	132.00	132.00			132.00
Passage	F75	SG30	118.00	118.00	129.00	129.00			129.00
Exit	F89	SG50							
Single Dummy	---	SG40	58.00	58.00	71.00	71.00	71.00		

Ⓢ (IC) Indicates function available with **Best, Falcon and Arrow** Interchangeable Core. Prices do not include cores. For IC Core pricing see pages L105 – L106. For Keying charges see page L115.

STANDARD DUTY CYLINDRICAL LEVERSETS ANSI STANDARD A156.2, GRADE 2

Optional Interchangeable Core for **Best, Falcon and Arrow**

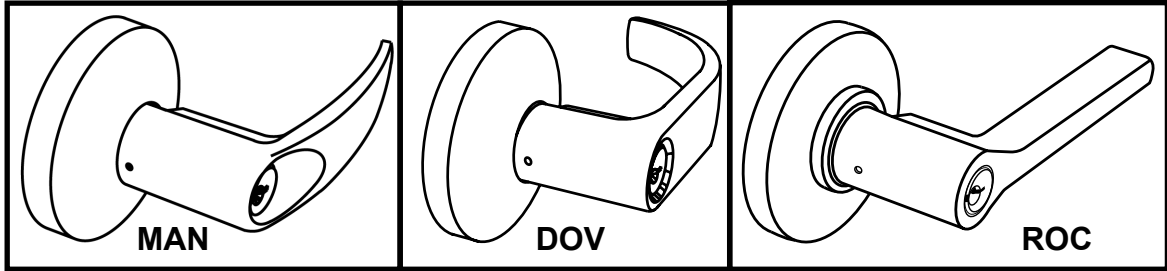

STOCK ITEM PRICES IN BOLD
NON-STOCK FINISHES AND DESIGNS AVAILABLE WITH FACTORY LEAD TIME
AND SUBJECT TO MINIMUM ORDER.

FUNCTIONS	ANSI	ITEM #	US26D	US3	US10B, 26, 15, 15A, 4	PCS / MC		
Entrance	F109	MAN00 / DOV00 / ROC00	\$145.00	\$145.00	\$158.00	10		
		ICMAN00 / ICDOV00 / ICROC00	145.00					
Storeroom	F91	MAN05 / DOV05 / ROC05	145.00					
		ICMAN05 / ICDOV05 / ICROC05	145.00					
Classroom	F84	MAN03 / DOV03 / ROC03	145.00					
		ICMAN03 / ICDOV03 / ICROC03	145.00					
Patio	F77	MAN10 / DOV10 / ROC10	129.00				129.00	146.00
Privacy	F76	MAN20 / DOV20 / ROC20	119.00				119.00	130.00
Passage	F75	MAN30 / DOV30 / ROC30	118.00				118.00	130.00
Exit	F89	MAN50 / DOV50 / ROC50	118.00					
Single Dummy	---	MAN40 / DOV40 / ROC40	58.00	58.00	71.00	20		

IC (IC) Indicates function available with **Best, Falcon and Arrow** Interchangeable Core. **Prices do not include cores.**
For IC Core pricing see pages L105 – L106. For Keying charges see page L115.

STANDARD DUTY CYLINDRICAL LEVERSETS ANSI STANDARD A156.2, GRADE 2

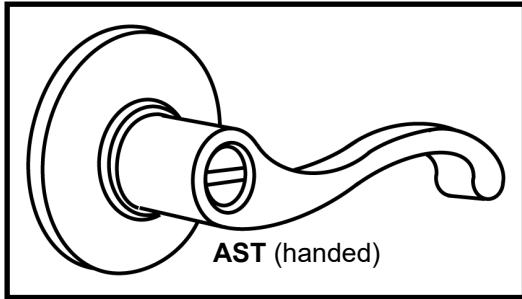

STOCK ITEM PRICES IN BOLD
NON-STOCK FINISHES AND DESIGNS AVAILABLE WITH FACTORY LEAD TIME
AND SUBJECT TO MINIMUM ORDER.

FUNCTIONS	ANSI	ITEM #	US3	US15, 15A	US26D	US10B, 26	PCS / MC
Entrance	F109	AST00	\$145.00	\$158.00	\$145.00	\$158.00	10
Storeroom	F91	AST05	145.00	158.00			
Classroom	F84	AST03	145.00	158.00			
Privacy	F75	AST20	119.00	132.00	119.00	132.00	
Passage	F75	AST30	118.00	130.00	116.00	130.00	
Exit	F89	AST50	118.00	130.00			
Single Dummy	----	AST40	58.00	71.00	58.00	71.00	

*SH SPECIFY HANDING FOR "AST" Design.

*HANDING: Entrance, Privacy and Passage functions are reversible non handed on AST designs. Specify handing for convenience. If handing is not available at time of shipment, opposite hand will be shipped. Other functions are handed.

► **PACKAGING INCLUDES**

- UL Listed 2 3/4" backset (2 1/4" x 1", square corner packed with 1/8" filler for 1 1/8" width). 2 3/8" available on request.
- Standard "C", 6-pin cylinder
- All locksets are packed with ASA Strike

8 ► **IC CORES, KEYING CHARGES**

For IC Core pricing see pages **L105 – L106**.
For Keying charges see page **L115**.

► **MOUNT**





2 hole wooden mount
List: \$163.18 Each

► **KEYWAYS**

6-pin solid brass "C" keyway standard. Optional: Schlage E, Schlage C-K, Russwin D1-2-3-4, Corbin 59 / 60, Arrow A, Corbin-Russwin L4, Sargent LA-LB-LC, Falcon / Weiser E, Yale 8, Yale GA and Kwikset. Can also accept Medeco, Assa, Kaba and **Cal-Royal HSK** High Security Cylinders. See **page L115** for keying charges and Cylinder PART #.

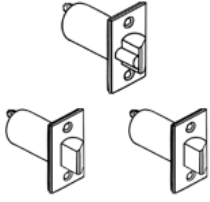
► **ADDITIONAL PARTS & CHARGES FOR CHALLENGER SERIES**

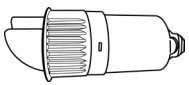
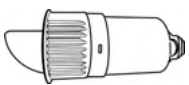
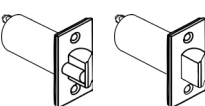
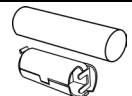
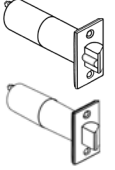
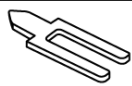
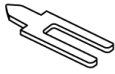
Backsets: UL listed 2 3/8", (2 1/4" x 1") faceplate, **NO EXTRA CHARGE** if ordered with lock only. Otherwise **\$30.00**List Each.

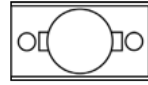
ILLUSTRATION	ITEM #	DESCRIPTION	FINISH	LIST PRICE
	UL-HIL238	2 3/8" UL-listed Dead latch, 2 1/4" x 1" Faceplate (key functions only)	US3, 26D, 10B, 10, 26	\$31.00
	UL-SLS238	2 3/8" UL-listed Spring Latch, 2 1/4" x 1" Faceplate (for privacy only)	US3, 26D, 10B, 10, 26	
	UL-SHIL238	2 3/8" UL-listed Spring Latch, 2 1/4" x 1" Faceplate (for passage only)	US3, 26D, 10B, 10, 26	
	ULSGPA238	2 3/8" UL-listed Dead Latch, 2 1/4" x 1" Faceplate (for SG10, SL10 Patio Function and SL101 Dormitory/ Assisted Living Function)	US26D	
	SLDRI-1	2 3/4" Entrance, Drive-in Latch bolt for G2 Lockset	ZINC	
	SLDRI-4	2 3/8" Entrance, Drive-in Latch bolt for G2 Lockset	ZINC	
	SLDRI-2	2 3/4" Privacy / Passage, Drive-in Latch bolt for G2 Lockset	ZINC	
	SLDRI-5	2 3/8" Privacy / Passage, Drive-in Latch bolt for G2 Lockset	ZINC	
EXTRA UL LISTED BACKSET				
	UL-HIL234	Dead Latch 2 3/4" 2 1/4" x 1 1/8" Faceplate	US3, 26D, 10B, 10, 26	31.00
	UL-SHIL234	Spring Latch 2 3/4" 2 1/4" x 1" Faceplate	US3, 26D, 10B, 10, 26	
3 3/4", 5" UL LISTED BACKSET				
	SL5	5" UL listed Extension Link	----	42.00
	SLD334	3 3/4" Dead latch, 2 1/4" x 1 1/8" Faceplate	US3, 26D, 10B	
	SLS334	3 3/4" Spring Latch, 2 1/4" x 1 1/8" Faceplate	US3, 26D, 10B	
TAIL PIECE				
	ICTP-03	6-pin Tail Piece for IC Challenger Series	----	4.50
	ICTP-04	7-Pin Tail Piece for IC Challenger Series		4.50
STRIKES				
	TS	T strike	US3, 26D, 10B, 10, 15, 26, 4	5.35
	FLS	Full lip strike	US3, 26D, 10B, 10, 15, 26, 4, 15A	
	LFA18	Latch front adapter to convert 1" faceplate to 1 1/8" wide door preparation	CLEAR	0.75

BARRINGTON BA Series List Price

STANDARD DUTY CYLINDRICAL LOCKSETS

ANSI A156.2 Series 4000 Grade 2

Optional Interchangeable Core for **Best, Falcon and Arrow**

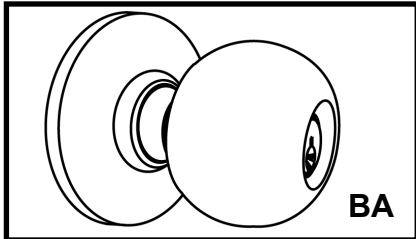

LIFETIME WARRANTY

MEETS
The Buy American Act

STOCK ITEM PRICES IN BOLD

NON-STOCK FINISHES AND DESIGNS AVAILABLE WITH FACTORY LEAD TIME AND SUBJECT TO MINIMUM ORDER.

Made in Korea								
FUNCTION	ANSI	ITEM #	US32D	US10B	US3	US10	US4, 26	PCS / MC
Entrance ****KA/4	F109	BA00	\$92.66	\$109.27	\$109.27	\$109.27	\$109.27	20
		ICBA00	105.76	119.81	105.76	119.81	119.81	
Combination Entrance and Single Cylinder Deadbolt -- KA / 2 packed together	NEW ITEM	BA00 / T220	156.56	---	---	---	---	20
Classroom	F84	BA03	109.27	114.81	114.81	114.81	114.81	
		ICBA03	115.13	129.19	115.13	129.19	129.19	
Storeroom	F86	BA05	92.66	109.27	109.27	109.27	109.27	
		ICBA05	105.76	119.81	105.76	119.81	119.81	
Communicating	F80	BA04	159.11	181.26	181.26	181.26	181.26	
Institution	F87	BA09	159.11	181.26	181.26	181.26	181.26	
Privacy	F76	BA20	76.15	81.69	81.69	81.69	81.69	
Passage	F75	BA30	65.07	76.15	76.15	76.15	76.15	
Exit	F89	BA50	65.07	76.15	76.15	76.15	76.15	
Single Dummy	----	BA40	27.69	36.00	36.00	36.00	36.00	50
Made in Taiwan								
FUNCTION	ANSI	ITEM #	US32D	US10B	US3	US10	US4, 26	PCS / MC
Entrance ****KA / 4	F109	TBA00	81.26	95.96	95.96	95.96	95.96	20
		ICTBA00	81.26	95.96	95.96	95.96	95.96	
Classroom	F84	TBA03	93.61	110.44	110.44	110.44	110.44	
		ICTBA03	93.61	110.44	110.44	110.44	110.44	
Storeroom	F86	TBA05	81.26	95.96	95.96	95.96	95.96	
		ICTBA05	81.26	95.96	95.96	95.96	95.96	
Storelock	F91	TBA02	159.11	186.16	186.16	186.16	186.16	
Communicating	F80	TBA04		186.16	186.16			
Institution	F87	TBA09	186.16	186.16	186.16	186.16	186.16	
Privacy	F76	TBA20	59.11	69.76	69.76	69.76	69.76	
Passage	F75	TBA30	54.21	64.01	64.01	64.01	64.01	
Exit	F89	TBA50	54.21	64.01	64.01	64.01	64.01	
Single Dummy	----	TBA40	26.63	31.42	31.42	31.42	31.42	50

IC Indicates function available with **Best, Falcon and Arrow** Interchangeable Core. Prices do not include cores. For IC Core pricing see pages L105 – L106. For Keying charges see page L115.

POLYGON PLG Series List Price

STANDARD DUTY CYLINDRICAL LOCKSETS

ANSI A156.2 Series 4000 Grade 2

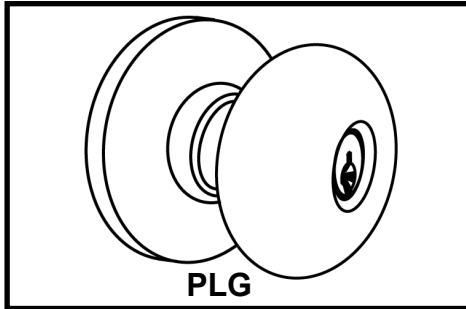

LIFETIME WARRANTY

MEETS
The Buy American Act

STOCK ITEM PRICES IN BOLD
NON-STOCK FINISHES AND DESIGNS AVAILABLE WITH FACTORY LEAD TIME
AND SUBJECT TO MINIMUM ORDER.

FUNCTION	ANSI	ITEM #	US32D	US3, 10B	US4, 10	PCS / MC
Entrance *****KA / 4	F109	PLG00	\$92.66	\$109.27	\$115.87	20
Classroom	F91	PLG03	109.27	114.81	121.73	
Storeroom	F84	PLG05	92.66	109.27	115.87	
Storelock	F91	PLG02	168.59	192.13	192.13	
Communicating	F80	PLG04				
Institution	F87	PLG09				
Privacy	F76	PLG20	80.62	86.59	86.59	
Passage	F75	PLG30	68.91	80.62	80.62	
Exit	F89	PLG50	68.91	80.62	80.62	
Single Dummy	----	PLG40	29.39	38.13	38.13	50

► **PACKAGING INCLUDES**

- UL Listed 2 3/4" Backset (2 1/4"x 1 1/8" faceplate)
- Standard "C", 6-pin cylinder
- ASA Strike

► **KEYWAYS**

6-pin solid brass "C" keyway standard. Optional: Schlage E, Schlage C-K, Russwin D1-2-3-4, Corbin 59 / 60, Corbin-Russwin L4, Sargent LA-LB-LC, Falcon / Weiser E, Arrow A, Yale 8, Yale GA and Kwikset. Can also accept Medeco, Assa, Kaba and **Cal-Royal HSK** High Security Cylinders. See **page L115** for keying charges and Cylinder PART #.

8 ► **IC CORES, KEYING CHARGES**









For IC Core pricing see pages **L105 – L106**.
 For Keying charges see page **L115**.

► **TACTILE / LEAD LINING**

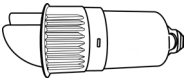
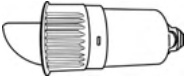
- Lead Lining Part # **LEAD**, Add **\$326.23 List**
- Tactile Part # **TAC**, Add **\$66.48List**

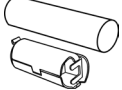
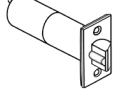
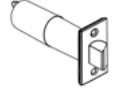
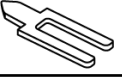
► **ADDITIONAL PARTS & CHARGES FOR BARRINGTON AND POLYGON SERIES**

Backsets: UL listed 2 3/8", (2 1/4" x 1") faceplate, **NO EXTRA CHARGE** if ordered with lock only. Otherwise **\$29.39 List Each**.

ILLUSTRATION	ITEM #	DESCRIPTION	FINISH	LIST PRICE
	ULSLD238	BA Series UL-listed Dead Latch 2 3/8" PLG Series UL-listed Dead Latch 2 3/8" 2 1/4" x 1" Faceplate	US3, 32D, 10B	\$29.40
	ULSLS238	BA Series UL-listed Spring Latch 2 3/8" PLG Series UL-listed Spring Latch 2 3/8" 2 1/4" x 1" Faceplate	US3, 32D, 10B	
	SLDRI-1	2 3/4" Entrance, Drive-in Latch bolt for G2 Lockset	ZINC	
	SLDRI-4	2 3/8" Entrance, Drive-in Latch bolt for G2 Lockset	ZINC	
	SLDRI-2	2 3/4" Privacy / Passage, Drive-in Latch bolt for G2 Lockset	ZINC	
	SLDRI-5	2 3/8" Privacy / Passage, Drive-in Latch bolt for G2 Lockset	ZINC	
EXTRA UL LISTED BACKSET				
	ULSLD234	Dead Latch 2 3/4" 2 1/4" x 1 1/8" Faceplate	US3, 26D, 10B, 10, 26	29.40
	ULSLS234	Spring Latch 2 3/4" 2 1/4" x 1 1/8" Faceplate	US3, 26D, 10B, 10, 26	
3 3/4", 5" UL LISTED BACKSET				
	SL5	5" UL listed Extension Link	----	42.42
	SLD334	BA Series 3 3/4" Dead latch PLG Series 3 3/4" Dead latch 2 1/4" x 1 1/8" Faceplate	US3, 26D, 10B	
	SLS334	BA Series 3 3/4" Spring Latch PLG Series 3 3/4" Spring Latch 2 1/4" x 1 1/8" Faceplate	US3, 26D, 10B	
TAIL PIECE				
	ICTP-03	6-pin Tail Piece for ICBA Series	----	4.15
	ICTP-04	7 Pin Tail Piece for ICBA Series		4.15
	ICTP-08	Tail Piece for ICTBA Only		4.15
STRIKES				
	TS	T-Strike	US3, 26D, 10B, 10, 15, 26, 4	5.33
	FLS	Full Lip Strike		

COLUMBUS Series List Price

ANSI A156.2 GRADE 3 CYLINDRICAL LOCKSET, ORBIT STYLE

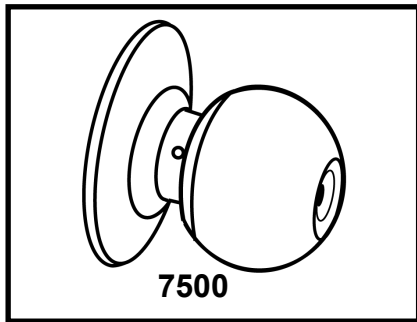

**LIFETIME
WARRANTY**

STOCK ITEM PRICES IN BOLD

NON-STOCK FINISHES AND DESIGNS AVAILABLE WITH FACTORY LEAD TIME AND SUBJECT TO MINIMUM ORDER.

FUNCTION	ANSI	ITEM #	US32D	US3,5	US10B	US4, 10, 15, 15A	PCS / MC
Entrance KA / 4	F109	7500	\$52.82	\$55.81	\$55.81	\$55.81	20
Classroom	F84	7503	56.34	59.32	59.32	59.32	
Storeroom	F86	7505	52.82	55.81	55.81	55.81	
Privacy	F76	7520	39.94	42.81	42.81	42.81	
Passage	F75	7530	38.13	41.11	41.11	41.11	
Single Dummy	---	7540	20.66	23.54	23.54	23.54	



► PACKAGING INCLUDES

- Adjustable 2 3/8" to 2 3/4" backset square corner. Preset 2 3/8"
- Standard "C", 6-pin cylinder
- T-strike

► KEYWAYS

6-pin solid brass "C" keyway standard. Optional: Schlage E, Schlage C-K, Russwin D1-2-3-4, Corbin 59 / 60, Corbin-Russwin L4, Sargent LA-LB-LC, Falcon / Weiser E, Arrow A, Yale 8, Yale GA and Kwikset.
Can also accept Medeco, Assa, Kaba and **Cal-Royal HSK** High Security Cylinders. See **page L115** for keying charges and Cylinder PART #.

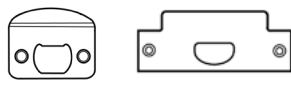
► ADDITIONAL PARTS & CHARGES

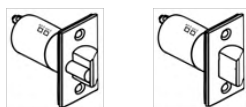
ILLUSTRATION	ITEM #	DESCRIPTION	FINISH	LIST PRICE
 <p>FLS ASAST</p>	FLS	Full Lip Strike	US3, 26D, 10B, 10, 15, 26, 4, 5, 15A	\$5.33
	ASAST	ASAANSI Strike	US3, 26D, 26	4.98
				US10, 10B, 4, 5
 <p>EXASA-175</p>	EXASA-175	Extended Lip ANSI Strike 1 3/4" Lip Extension from Screw Center Line	US32D, DURO	44.91
 <p>7500ADJ 7520ADJ</p>	7500ADJ	7500 Series Entrance Dead latch Adjustable 2 3/8" or 2 3/4" Backset 2 1/4" x 1" Faceplate	US3, 26D, 10B	27.73
	7520ADJ	7500 Series Privacy Spring latch Adjustable 2 3/8" or 2 3/4" Backset 2 1/4" x 1" Faceplate		

HIL Series List Price

INTERCONNECTED ENTRANCE LEVER SERIES

ANSI - A156.12 SERIES 5000, GRADE 2, UL LISTED

Optional Interchangeable Core for Best, Falcon and Arrow
With Interconnecting Mechanism, **Can be used with 4" CTC**

 <small>3 HOUR FIRE RATED UL10C, UBC7-2-1997</small>	LIFETIME WARRANTY	BHMA CERTIFIED <small>Be Safe. Be Secure. Look for the Mark.</small>	MEETS <i>The Buy American Act</i>
---	--------------------------	--	---

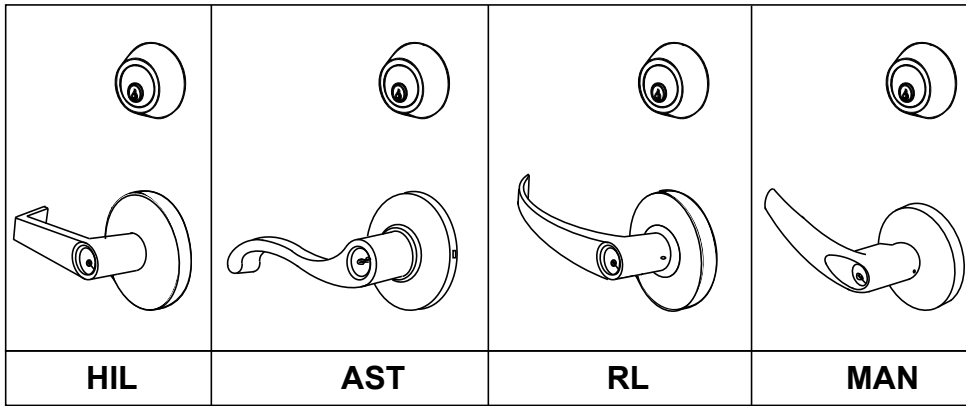

STOCK ITEM PRICES IN BOLD
NON-STOCK FINISHES AND DESIGNS AVAILABLE WITH FACTORY LEAD TIME
AND SUBJECT TO MINIMUM ORDER.

FUNCTION	ANSI	ITEM #	US26D	US3, 15	US10B	US4, 5, 26	PCS / MC
Entrance, Double Locking	F109	HIL00	\$322.48	\$322.48	\$343.04	\$343.04	10
		⚙️ ICHIL00		322.48	343.04	343.04	
Entrance, Single Locking	F75	HIL30	293.20	293.20	313.96	313.96	
		⚙️ ICHIL30					
Entrance, Double Locking	F109	HILAST00	322.48	322.48	343.04	343.04	
		⚙️ ICHILAST00	322.48	322.48	343.04	343.04	
Entrance, Single Locking	F75	HILAST30	293.20	293.20	313.96	313.96	
		⚙️ ICHILAST30					
Entrance, Double Locking	F109	HILRL00	322.48	322.48	343.04	343.04	
		⚙️ ICHILRL00	322.48	322.48	343.04	343.04	
Entrance, Single Locking	F75	HILRL30	293.20	293.20	313.96	313.96	
		⚙️ ICHILRL30					
Entrance, Double Locking	F109	HILMAN00	322.48	322.48	343.04	343.04	
		⚙️ ICHILMAN00					
Entrance, Single Locking	F75	HILMAN30	293.20	293.20	313.96	313.96	
		⚙️ ICHILMAN30		293.20	293.20	313.96	313.96

* Specify handing when ordering AST design

- ⚙️** Indicates deadbolt available with Interchangeable Core. Cores are compatible 6 or 7 pin with **Best, Falcon and Arrow**.
Prices do not include cores. For IC Core pricing see pages L105 – L106. For Keying charges see page L115.
- ⚙️⚙️** Indicates deadbolt and entrance lever available with Interchangeable Core. Cores are compatible 6 or 7 pin with **Best, Falcon and Arrow**.
Prices do not include cores. For IC Core pricing see pages L105 – L106. For Keying charges see page L115.

JHIL Series List Price

INTERCONNECTED ENTRANCE LEVER SERIES

ANSI - A156.12 SERIES 5000, GRADE 2, UL LISTED

- Optional Interchangeable Core for Best, Falcon and Arrow
 - Optional Large Format Interchangeable Core for Schlage
- With Interconnecting Mechanism, Can be used with 4" or 5 1/2" CTC

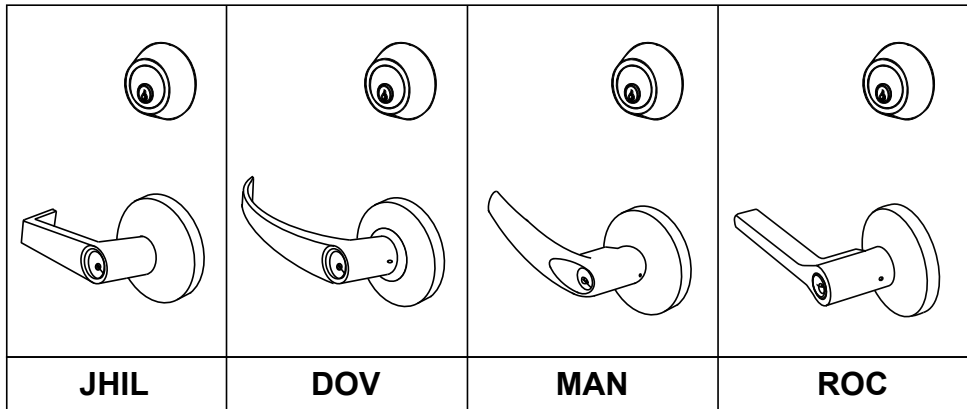

MEETS
The Buy American Act

STOCK ITEM PRICES IN BOLD

NON-STOCK FINISHES AND DESIGNS AVAILABLE WITH FACTORY LEAD TIME AND SUBJECT TO MINIMUM ORDER.

FUNCTION	ANSI	ITEM #	US26D	US3	US15	US10B	PCS / MC																																																																																																
Entrance, Double Locking	F109	JHIL00	\$322.48	\$322.48	\$322.48	\$343.04	10																																																																																																
		•• ICJHIL00	322.48					Entrance, Single Locking	F75	JHIL30	293.20	293.20	293.20	313.96	• ICJHIL30	293.20	293.20	313.96	• ICSCJHIL30	342.40	342.40	342.40	363.27	Entrance, Double Locking	F109	JHILROC00	322.48	322.48	322.48	343.04	•• ICJHILROC00	322.48	322.48	322.48	343.04	Entrance, Single Locking	F75	JHILROC30	293.20	293.20	293.20	313.96	• ICJHILROC30	293.20	293.20	313.96	• ICSCJHILROC30	342.40	342.40	342.40	363.27	Entrance, Double Locking	F109	JHILDOV00	322.48	322.48	322.48	343.04	•• ICJHILDOV00	322.48	322.48	322.48	343.04	Entrance, Single Locking	F75	JHILDOV30	293.20	293.20	293.20	313.96	• ICJHILDOV30	293.20	293.20	313.96	• ICSCJHILDOV30	342.40	342.40	342.40	363.27	Entrance, Double Locking	F109	JHILMAN00	322.48	322.48	322.48	343.04	•• ICJHILMAN00	322.48	322.48	322.48	343.04	Entrance, Single Locking	F75	JHILMAN30	293.20	293.20	293.20	313.96	• ICJHILMAN30	293.20	293.20	293.20	313.96
Entrance, Single Locking	F75	JHIL30	293.20	293.20	293.20	313.96																																																																																																	
		• ICJHIL30		293.20	293.20	313.96																																																																																																	
		• ICSCJHIL30	342.40	342.40	342.40	363.27																																																																																																	
Entrance, Double Locking	F109	JHILROC00	322.48	322.48	322.48	343.04																																																																																																	
		•• ICJHILROC00	322.48	322.48	322.48	343.04																																																																																																	
Entrance, Single Locking	F75	JHILROC30	293.20	293.20	293.20	313.96																																																																																																	
		• ICJHILROC30		293.20	293.20	313.96																																																																																																	
		• ICSCJHILROC30	342.40	342.40	342.40	363.27																																																																																																	
Entrance, Double Locking	F109	JHILDOV00	322.48	322.48	322.48	343.04																																																																																																	
		•• ICJHILDOV00	322.48	322.48	322.48	343.04																																																																																																	
Entrance, Single Locking	F75	JHILDOV30	293.20	293.20	293.20	313.96																																																																																																	
		• ICJHILDOV30		293.20	293.20	313.96																																																																																																	
		• ICSCJHILDOV30	342.40	342.40	342.40	363.27																																																																																																	
Entrance, Double Locking	F109	JHILMAN00	322.48	322.48	322.48	343.04																																																																																																	
		•• ICJHILMAN00	322.48	322.48	322.48	343.04																																																																																																	
Entrance, Single Locking	F75	JHILMAN30	293.20	293.20	293.20	313.96																																																																																																	
		• ICJHILMAN30	293.20	293.20	293.20	313.96																																																																																																	
		• ICSCJHILMAN30	342.40	342.40	342.40	363.27																																																																																																	

•• (IC) Indicates deadbolt available with Interchangeable Core. Cores are compatible 6 or 7 pin with **Best, Falcon and Arrow**.
Prices do not include cores. For IC Core pricing see page L105. For Keying charges see page L115

• (ICSC) Indicates deadbolt available with Large Format Interchangeable Core for Schlage.
Prices do not include cores. For IC Core pricing see page L106. For Keying charges see page L115.

► **PACKAGING INCLUDES**

- UL Listed 2 3/4" backset, 2 1/4" x 1 1/8" faceplate for HIL Series
- UL Listed 2 3/4" backset, 2 1/4" x 1" faceplate with 1/8" plastic filler for **JHIL Series**
- Standard "C", 6-pin cylinder
- T-Strike, square strike 2 3/4" X 1 1/8" for deadbolt

► **KEYWAYS**

6-pin solid brass "C" keyway standard. Optional: Schlage E, Schlage C-K, Russwin D1-2-3-4, Corbin 59 / 60, Corbin-Russwin L4, Corbin-Russwin L4, Sargent LA-LB-LC, Falcon / Weiser E, Arrow A, Yale 8, Yale GA and Kwikset. Can also accept Medeco, Assa, Kaba and **Cal-Royal HSK** High Security Cylinders. See **page L115** for keying charges and Cylinder PART #.



► **IC CORES, KEYING CHARGES**

For IC Core pricing see pages **L105 – L106**. For Keying charges see page **L115**.

► **ADDITIONAL PARTS & CHARGES FOR HIL AND JHIL SERIES**

Backset: UL Listed 2 3/8" with 2 1/4" x 1 1/8" Faceplate, **NO EXTRA CHARGE** if ordered with lock only.

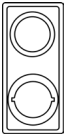
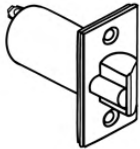
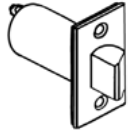
If ordered separately **ADD \$31.40 List Each**.

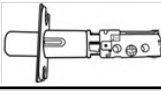
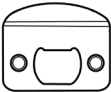
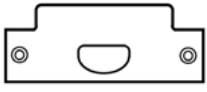
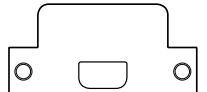
ILLUSTRATION	ITEM #	DESCRIPTION	FINISH	LIST PRICE
	HILESC1	Escutcheon Plate for Exterior Trim for HIL and JHIL Series (JHIL used with 4" CTC Only)	US3, 26D, 15, 10B	\$29.15
	UL-HIL238	For HIL & JHIL: Dead Latch 2 3/8" for lever lock, 2 1/4" x 1" faceplate (for entry only)	US3, 26D, 10B	29.39
	UL-HIL234	For HIL: Dead Latch 2 3/4" for lever lock 2 1/4" x 1 1/8" faceplate (for entry only)		
	ULJHIL234	For JHIL: Dead Latch 2 3/4" for lever lock 2 1/4" x 1" faceplate (for entry only)		
	UL-SHIL238	FOR HIL & JHIL: 2 3/8" UL-listed Spring Latch, 2 1/4" x 1" faceplate (for passage only)		
	UL-SHIL234	For HIL: 2 3/4" UL-listed Spring Latch 2 1/4" x 1 1/8" faceplate (for passage only)		
	ULSJHIL234	For JHIL: 2 3/4" UL-listed Spring Latch 2 1/4" x 1" faceplate (for passage only)		
	ULJHILADJ	Adjustable Deadbolt Latch 2 3/8" or 2 3/4" for JHIL	31.40	
	T220ADJ	Adjustable Deadbolt Latch 2 3/8" or 2 3/4" for HIL		
STRIKES				
	FLS	Full Lip Strike	US3, 26D, 10B, 15, 4, 5, 26	5.33
	ASAST	ASA Strike	US3, 26D	4.98
			US10B	7.47
	EXASA-175	Extended Lip ANSI Strike 1 3/4" Lip Extension from Screw Center Line	US32D, DURO	44.91

EPIC Series List Price

LIGHT DUTY CYLINDRICAL LEVERSETS

MEETS ANSI STANDARD A156.2, GRADE 3

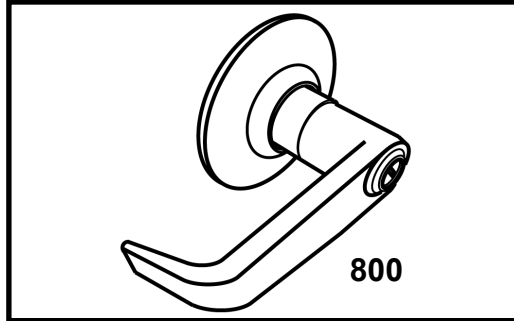

STOCK ITEM PRICES
IN BOLD
NON-STOCK FINISHES AND DESIGNS
AVAILABLE WITH FACTORY LEAD TIME
AND SUBJECT TO MINIMUM ORDER.

COMMERCIAL PACKAGING					
ENTRANCE leversets, Schlage "C" 5 pin keyway, KD packed with ASA Strike, 2 3/4" backset (1 1/8" x 2 1/4" square corner).					
ITEM #	ANSI	FUNCTION	FINISH	LIST PRICE	PCS / MC
800	F109	Entrance Cylindrical Lock with 4 7/8" ASA Commercial Strike, 5 pin Schlage "C" cylinder, KD	US26D, 3	\$72.85	24
800			US4	79.88	
800			US10B	89.25	
ENTRANCE leversets, Schlage "C" 5 pin keyway, KD packed with ASA Strike, 2 3/4" backset (1 1/8" x 2 1/4" square corner).					
*802	F76	Privacy	US26D	65.82	24
803	F75	Passage	US26D	63.47	
*802	F76	Privacy	US10B	82.22	
803	F75	Passage	US10B	79.88	
*802	F76	Privacy	US4	72.85	
*802	F76	Bathroom (split finish)	US4 / US26D	72.85	
803	F75	Passage	US4	70.50	
805	----	Dummy	US26D, 3, 5, 26, 10B, 4	30.57	36
RESIDENTIAL PACKAGING					
PRIVACY AND PASSAGE leversets packed with Full Lip Strike round corner, 2 3/8" backset (1" x 2 1/4" round corner).					
ITEM #	ANSI	FUNCTION	FINISH	LIST PRICE	PCS / MC
*RES802	F76	Privacy	US26D	65.82	24
RES803	F75	Passage	US26D	63.47	
*802	F76	Privacy	US3, 26	65.82	
803	F75	Passage	US3, 26	63.47	
*802	F76	Privacy	US5	81.37	
803	F75	Passage	US5	70.29	
805	----	Dummy	US26D, 3, 5, 26, 10B, 4	30.57	36

*Turning inside lever or closing door releases button



**Other strikes and backsets available upon request subject to minimum quantity and lead time.

► **KEYWAYS**

5-pin solid brass "C" keyway standard.

► **ADDITIONAL PARTS & CHARGES FOR EPIC SERIES**

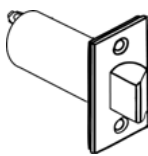
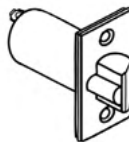
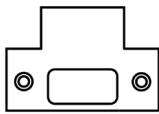
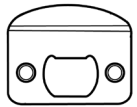
Backset: 2 3/8" with 2 1/4" x 1 1/8" Faceplate, **NO EXTRA CHARGE** if ordered with lock only.
If ordered separately **ADD \$31.40 List Each.**

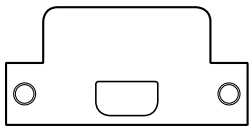
ILLUSTRATION	ITEM #	DESCRIPTION	FINISH	LIST PRICE
	8PAS238	Round Corner 2 3/8" Passage Spring Latch	US3, 26D, 10B	\$29.39
	8PRI238	Round Corner 2 3/8" Privacy Spring Latch	US3, 26D, 10B	
	ULSLS234	Round Corner 2 3/4" Spring Latch	US3, 26D, 10B	
	ULSLD234	Square Corner 2 3/4" x 1 1/8" Dead latch	US3, 26D, 10B	
	EPD238 / ULSLD238	Square Corner 2 3/8" x 1" Dead latch	US3, 26D, 10B	
STRIKES				
	TS	T-Strike	US3, 26D, 10B, 26, 4	5.33
	FLS	Full Lip Strike		
	ASAST	ASA Strike	US3, 26D, 26	4.98
			US10B, 4	7.47
	EXASA-175	Extended Lip ANSI Strike 1 3/4" Lip Extension from Screw Center Line	US32D, DURO	44.91

KEYING CHARGES

ITEM #	DESCRIPTION	LIST PRICE
KARES	Key alike	5.81
MKRES	Master key (Including KA charges)	7.35
CMKRES	Builder construction master key (Including KA & MK Charges)	10.19
GMKRES	Grand master key (Including KA, MK)	13.15

CRB Series List Price

HEAVY DUTY DEADBOLTS, ANSI STANDARD- A156.5, GRADE 1

- Optional Interchangeable Core for **Best, Falcon and Arrow**
- Optional Interchangeable Core for **Schlage Full Size** format

	LIFETIME WARRANTY	BHMA™ CERTIFIED <small>Be Safe. Be Secure. Look for the Mark.</small>	MEETS <i>The Buy American Act</i>
---	--------------------------	---	---

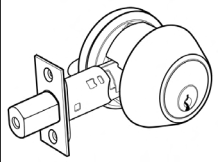
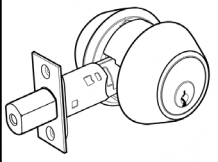
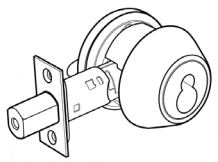
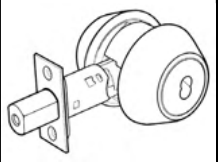
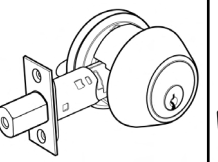
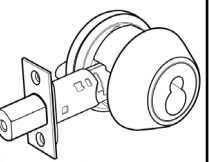
					
CRB800	CRB700	● ICRB800 ● ICSCRB800	● ICRB700	CRB600	● ICRB600 ● ICSCRB600

STOCK ITEM PRICES IN BOLD
 NON-STOCK FINISHES AND DESIGNS AVAILABLE WITH FACTORY LEAD TIME
 AND SUBJECT TO MINIMUM ORDER.

FUNCTION	ANSI	ITEM #	US26D	US3, 15	US10B	US4, 5, 26	PCS / MC
Grade 1, UL Listed Single Cylinder Deadbolt, "C" Keyway	E0152 NEW ITEM	CRB800	\$157.41	\$157.41	\$162.09	\$162.09	20
		● ICRB800	179.45	179.45	179.45	179.45	
		● ICSCRB800	179.45	179.45	179.45	179.45	
Grade 1, UL Listed Double Cylinder Deadbolt, "C" Keyway	E0142	CRB700	197.35	197.35	202.03	202.03	20
		● ICRB700	197.35	197.35	202.03	202.03	
Classroom Deadbolt lock, Deadbolt thrown or retracted by key outside. Inside turn unit will retract bolt only. Bolt automatically deadlocks when fully thrown	F109 NEW ITEM	CRB600	162.09	162.09	166.78	166.78	20
		● ICRB600	162.09	162.09	166.78	166.78	
		● ICSCRB600	183.93	183.93	183.93	183.93	

- (IC) Indicates deadbolt available with Interchangeable Core. Cores are compatible 6 or 7 pin with **Best, Falcon and Arrow**.
- (ICSC) Indicates deadbolt available with Large Format Interchangeable Core for Schlage. **Prices do not include cores.**
 For IC Core pricing see pages L105 – L106. For Keying charges see page L115.

▶ **PACKAGING INCLUDES**

- Standard "C" 6-pin cylinder
- Standard UL Listed 2 3/4" backset, optional 2 3/8" backset available. Please specify.
- Latch: Backset latch size 1 1/8" x 2 1/4" faceplate.
- Strike: 1 1/8" x 2 3/4", packed with 3" screws with wood frame reinforcer.

▶ **KEYWAYS**

6-pin solid brass "C" keyway standard. Optional: Schlage E, Schlage C-K, Russwin D1-2-3-4, Corbin 59 / 60, Corbin-Russwin L4, Corbin-Russwin L4, Sargent LA-LB-LC, Falcon / Weiser E, Arrow A, Yale 8, Yale GA and Kwikset. Can also accept Medeco, Assa, Kaba and **Cal-Royal HSK** High Security Cylinders. See **page L115** for keying charges and Cylinder PART #.

▶ **ANTI MICROBIAL COATING**

Available on US26D and US32D finishes. Add **\$78.59**List. Prefix "ANTB" before **Part #**.

▶ **IC CORES, KEYING CHARGES**

For IC Core pricing see pages **L105 – L106**. For Keying charges see page **L115**.

▶ **ADDITIONAL PARTS & CHARGES FOR CRB SERIES**

Backsets: 2 3/8", NO EXTRA CHARGE if ordered with lock only. Otherwise **\$31.40 List Each**.

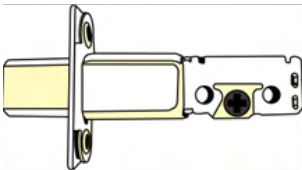
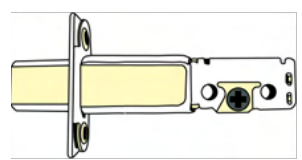
ILLUSTRATION	ITEM #	DESCRIPTION	FINISH	LIST PRICE
	B800-238	2 3/8" backset (2 1/4" x 1") faceplate	US3, 26D, 10B	\$31.40
	B800-234	2 3/4" backset (2 1/4" x 1 1/8") faceplate	US3, 26D, 10B	

T300 Series List Price

COMMERCIAL / RESIDENTIAL HEAVY DUTY DEADBOLTS

ANSI STANDARD A 156.5, GRADE 2

● Optional Interchangeable Core for **Best, Falcon and Arrow**
Optional Conversion Kit for up to 2 1/4" Thick Doors

 3 HOUR FIRE RATED UL10C, UBC7-2-1997	LIFETIME WARRANTY	MEETS <i>The Buy American Act</i>	HURRICANE APPROVED HARDWARE FLORIDA BUILDING CODE: FL 13922-R1 ASTM E1886/E1996 ASTM E330 TAS 201, 202, 203 UL10B UL10C
---	--------------------------	---	--

ULT360 / CL600	ULT362	ULT700	ULID363	ULID365

STOCK ITEM PRICES IN BOLD
NON-STOCK FINISHES AND DESIGNS AVAILABLE WITH FACTORY LEAD TIME AND SUBJECT TO MINIMUM ORDER

FUNCTION	ANSI	ITEM #	US3	US26D	US10B	US4	US15	US26	US10	US5	PCS / MC
Heavy Duty Single Cylinder Deadbolt, UL Listed	E0152	ULT360	\$101.92	\$101.92	\$109.48	\$123.00	\$104.37	\$101.92	\$101.92	\$106.29	20
Heavy Duty Single Cylinder Deadbolt, UL Listed	E0152	●ICULT360	105.54	105.54	113.00	108.31	107.99	105.54	105.54	109.80	
Heavy Duty Double Cylinder Deadbolt, UL Listed	E0142	ULT362	137.71	137.71	157.09	140.47	140.05	134.40	134.40	142.18	
Heavy Duty Double Cylinder Deadbolt, UL Listed	E0142	●ICULT362	144.63	144.63	149.85	147.40	147.08	141.54	141.54	149.10	
Classroom deadbolt lock. UL Listed. Deadbolt thrown or retracted by key outside. Inside turn unit will retract bolt only. Bolt automatically deadlocks when fully thrown. Fixed 2 1/4" backset latchbolt 2 1/2" Backset available upon request Part # ULJHILADJ	E0172	CL600	132.70	132.70	138.13	132.70	132.70	132.70	132.70	132.70	
		●ICCL600	139.73	139.73	147.93	139.73	139.73	139.73	139.73	139.73	
UL Listed One Sided Latch Bolt retracted by thumb turn, no outside trim . Visible from one side of door only.	---	ULID363	56.55	56.55	62.09	62.09	62.09	62.09	62.09	62.09	
UL Listed One Sided Latch Bolt retracted by thumb turn unit. Blank plate on external trim to be used on bore holes 1 1/2" and 2 1/2" diameter.	---	ULID365	63.16	63.16	69.86	69.86	69.86	69.86	69.86	69.86	
UL Listed One-Way Deadbolt Lock Deadbolt thrown or retracted by key outside. Blank plate on internal trim to be used on bore holes 1 1/2" and 2 1/2" diameter. Bolt automatically deadlocks when fully thrown. (Exposed Screws)	E1161	ULT700	90.00	90.00	106.07	106.07	106.07	106.07	106.07	106.07	
		●ICULT700	90.00	90.00	106.07	106.07	106.07	106.07	106.07	106.07	

● (IC) Indicates functions available with Interchangeable Core. Cores are compatible 6 or 7 pin with **Best, Falcon and Arrow**.
Prices do not include cores. For IC Core pricing see pages L105 – L106. For Keying charges see page L115.

► **PACKAGING INCLUDES**

- Standard "C" 6-pin cylinder
- Standard : Adjustable UL Listed 3 Hour Fire Rating 2 3/8" or 2 3/4" latchbolt.
- Latch: Backset latch size 1" x 2 1/4" faceplate, packed with latch front adapter to convert 1" face plate for 1 1/8" wide door preparations
- Strike: 1 1/8" x 2 3/4", packed with 3" screws with wood frame reinforcer.

► **KEYWAYS**



6-pin solid brass "C" keyway standard. Optional: Schlage E, Schlage C-K, Russwin D1-2-3-4, Arrow A, Corbin 59 / 60, Corbin-Russwin L4, Sargent LA-LB-LC, Falcon / Weiser E, Yale 8, Yale GA and Kwikset. Can also accept Medeco, Assa, Kaba and **Cal-Royal HSK** High Security Cylinders. See **page L115** for keying charges and Cylinder PART #.

► **IC CORES, KEYING CHARGES**

For IC Core pricing see pages **L105 – L106**. For Keying charges see page **L115**.

► **ADDITIONAL PARTS & CHARGES FOR T300 SERIES**

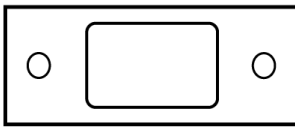
Backsets: 2 3/8", NO EXTRA CHARGE if ordered with lock only. Otherwise **\$31.40 List Each**.

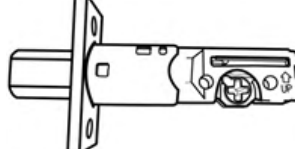
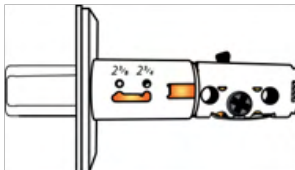
ILLUSTRATION	ITEM #	DESCRIPTION	FINISH	LIST PRICE
	T2STRK	Deadbolt strike 1 1/8" X 2 3/4"	US3, 10B, 26D	\$4.98
	CONVT360	Conversion Kit for 2 1/4" thick doors with tail piece and screws for ULT360 Single Cylinder Deadbolt		14.69
	CONVT362	Conversion Kit for 2 1/4" thick doors with tail piece and screws for ULT362 Double Cylinder Deadbolt		14.69
	ULT360ADJ	2 3/8" - 2 3/4" Adjustable Latch bolt for ULT360 and ULT362		31.40
	ULJHILADJ	Adjustable Deadbolt Latch 2 3/8" or 2 3/4" for CL600 Classroom Deadbolt		31.40

T400 Series List Price

COMMERCIAL / RESIDENTIAL HEAVY DUTY DEADBOLTS

ANSI STANDARD A 156.5, GRADE 2

OPTIONAL 6-PIN "C" OR 5-PIN KWIKSET KW1 KEYWAY

**LIFETIME
WARRANTY**

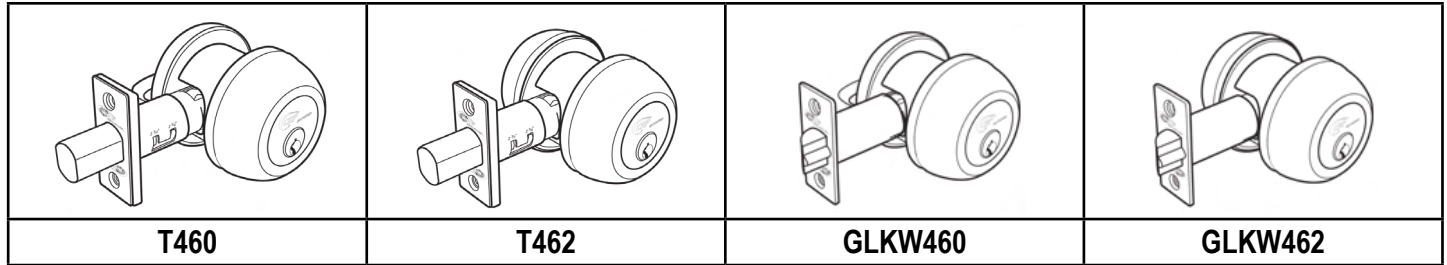

STOCK ITEM PRICES IN BOLD
NON-STOCK FINISHES AND DESIGNS AVAILABLE WITH FACTORY LEAD TIME
AND SUBJECT TO MINIMUM ORDER

DESCRIPTION	ANSI	ITEM #	US26D, US15, US3	US10B, VB (Venetian Bronze)	US5	PCS / MC
Single Cylinder Deadbolt, 6-pin "C" Keyway	E0152	T460	\$74.23	\$86.48	\$86.48	20
Double Cylinder Deadbolt, 6-pin "C" Keyway	E0142	T462	98.62	108.63	108.63	
Single Cylinder Deadbolt, 5-pin Kwikset KW1 Keyway	E0152	KWT460	74.23	86.48	86.48	
Double Cylinder Deadbolt, 5-pin Kwikset KW1 Keyway	E0142	KWT462	98.62	108.63	108.63	
Single Cylinder Deadbolt, 6-pin "C" Keyway	E0152	GL460 2 3/8" Backset	156.02	168.27	168.27	20
Single Cylinder Gate Latch, 6-pin "C" Keyway	E0152	GL460 / 234 2 3/4" Backset	156.02	168.27	168.27	
Double Cylinder Gate Latch, 6-pin "C" Keyway	E0142	GL462 2 3/8" Backset	180.41	190.42	190.42	
Double Cylinder Gate Latch, 6-pin "C" Keyway	E0142	GL462 / 234 2 3/4" Backset	180.41	190.42	190.42	
Single Cylinder Gate Latch, 5-pin Kwikset KW1 Keyway	E0152	GLKW460 2 3/8" Backset	156.02	168.27	168.27	
Single Cylinder Gate Latch, 5-pin Kwikset KW1 Keyway	E0152	GLKW460 / 234 2 3/4" Backset	156.02	168.27	168.27	
Double Cylinder Gate Latch, 5-pin Kwikset KW1 Keyway	E0142	GLKW462 2 3/8" Backset	180.41	190.42	190.42	
Double Cylinder Gate Latch, 5-pin Kwikset KW1 Keyway	E0142	GLKW462 / 234 2 3/4" Backset	180.41	190.42	190.42	

► **PACKAGING INCLUDES**

- Optional Standard "C" 6-pin cylinder or 5-pin Kwikset KW1
- Adjustable 2 3/4" and 2 3/8" backset.
- Latch: Standard 2 1/4" x 1" packed with 1 1/8" plastic filler to convert face plate to 1 1/8" wide door preparations
- Strike: 1 1/8" x 2 3/4", packed with 1 1/2" screws with wood frame reinforcer.





► **KEYWAYS**

Optional 6-pin solid brass "C" or 5 pin Kwikset KW1 keyway standard. Optional: Schlage E, Schlage C-K, Arrow A, Russwin D1-2-3-4, Corbin 59 / 60, Corbin-Russwin L4, Corbin-Russwin L4, Sargent LA-LB-LC, Falcon / Weiser E, Yale 8 and Yale GA. Can also accept Medeco, Assa, Kaba and **Cal-Royal HSK** High Security Cylinders. See **page L115** for keying charges and Cylinder PART #.

► **KEYING CHARGES**

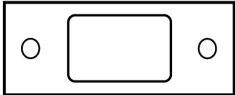
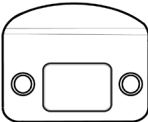
Refer to page L115.

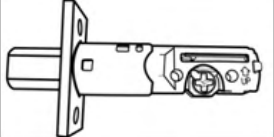
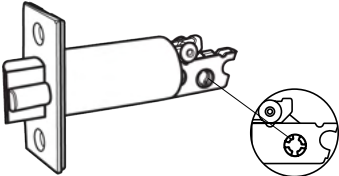
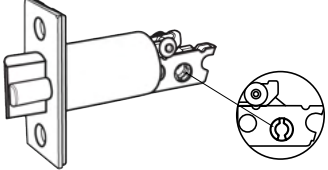

► **ADDITIONAL PARTS & CHARGES FOR T400 SERIES**

ILLUSTRATION	ITEM #	DESCRIPTION	FINISH	LIST PRICE
	T2STRK	Deadbolt strike 1 1/8" X 2 3/4"	US3, 10B, 26D	\$4.98
	DBFLS	Deadbolt Full Lip Strike, Round Corner	US3, 5, 10B, 15, 15A, 26	3.79
	SS114358	Deadbolt Security Strike 1 1/4" x 3 5/8", 1/4" Rad.	US3, 5, 26D	6.64
	DBS1214RC	Deadbolt Strike Round Corner 1" X 2 1/4", 1/4" Rad.		1.54
	DBS1214SC	Adjustable Deadbolt Latch 2 3/8" or 2 3/4" for CL600 Classroom Deadbolt		1.54
	T460ADJ	Adjustable 2 3/4" and 2 3/8" Latch Bolt	US3, 10B, 26D	27.49
	GL238	2 3/8" backset gate latch and for double cylinder deadbolt		91.01
	GL234	2 3/4" backset gate latch and for double cylinder deadbolt		
	SINGL238	2 3/8" backset gate latch and for single cylinder deadbolt		
	SINGL234	2 3/4" backset gate latch and for single cylinder deadbolt		

CB160 Series List Price

STANDARD DUTY DEADBOLTS, ANSI STANDARD - A156.5, GRADE 2
COMMERCIAL / RESIDENTIAL GR 2 DEADBOLTS / DEAD LATCHES
Grade 2 Specifications, Equivalent to Schlage B160 - Series Deadbolts

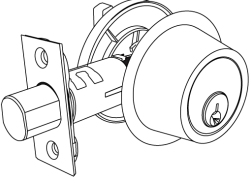
LIFETIME
WARRANTY

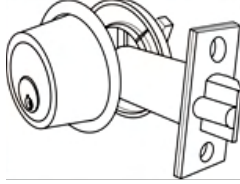
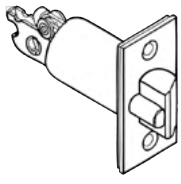
			
CB160	ADP160	GL160	GL238 (2 3/8") GL234 (2 3/4")

STOCK ITEM PRICES IN BOLD
NON-STOCK FINISHES AND DESIGNS AVAILABLE WITH FACTORY LEAD TIME
AND SUBJECT TO MINIMUM ORDER

DESCRIPTION	ANSI	ITEM #	US3, 26D	US10, 10B, 26, 4, 5, 15	PCS / MC
Standard Duty Single Cylinder Deadbolt	E0152	CB160	\$79.88	\$84.56	36
Standard Duty Double Cylinder Deadbolt	E0142	CB162	103.41	108.10	
Single Cylinder Gate Latch	E0152	GL160 (2 3/8" backset)	159.75	164.44	
Double Cylinder Gate Latch	E0142	GL162 (2 3/8" backset)	183.18	187.87	
Single Cylinder GateLatch	E0152	GL160 / 234 (2 3/4" backset)	159.75	164.44	
Double Cylinder Gate Latch	E0142	GL162234 (2 3/4" backset)	183.18	187.87	

► **PACKAGING INCLUDES**

- 2 1/2" Diameter Adapter Ring for 2 1/8" Door Preparations
- Standard "C" 6-pin cylinder
- Adjustable 2 3/4" and 2 3/8" backset
- For gate latches Fixed 2 3/4" and 2 3/8" latch bolt
- Latch: Backset latch size 1" x 2 1/4" faceplate, packed with latch front adapter to convert 1" face plate for 1 1/8" wide door preparations
- Strike: 1 1/8" x 2 3/4"

► **KEYWAYS**





6-pin solid brass "C" keyway standard. Optional: Schlage E, Schlage C-K, Russwin D1-2-3-4, Corbin 59 / 60, Corbin-Russwin L4, Sargent LA-LB-LC, Falcon / Weiser E, Arrow A, Yale 8, Yale GA and Kwikset. Can also accept Medeco, Assa, Kaba and **Cal-Royal HSK** High Security Cylinders. See page L115 for keying charges and Cylinder PART #.

► **KEYING CHARGES**

Refer to page L115.

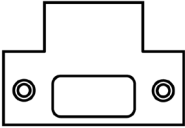
► **ADDITIONAL PARTS & CHARGES FOR CB160 SERIES**

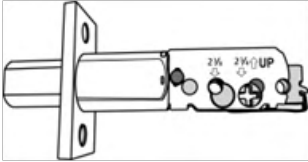
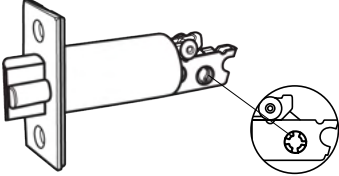
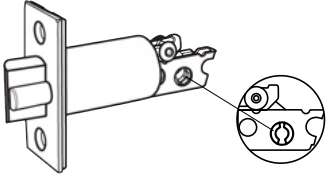
Backsets: 2 3/8", NO EXTRA CHARGE if ordered with lock only. Otherwise **\$31.40 List Each**.

ILLUSTRATION	ITEM #	DESCRIPTION	FINISH	LIST PRICE
	TS	T-Strike	US3, 26D, 10B, 26, 10, 4, 15	\$5.33
	T2STRK	Deadbolt Strike 1 1/8" X 2 3/4"	US3, 10B, 26D	4.98
	CB160ADJ	2 3/8" - 2 3/4" Adjustable Latch bolt for CB160		31.40
	GL238	2 3/8" backset gate latch and for double cylinder deadbolt		91.01
	GL234	2 3/4" backset gate latch and for double cylinder deadbolt		
	SINGL238	2 3/8" backset gate latch and for single cylinder deadbolt		
	SINGL234	2 3/4" backset gate latch and for single cylinder deadbolt		
	ADP160	Adapter Ring		US10B, 15, 26, 26D, 3, 4, 5

STANDARD DUTY DEADBOLTS Series

ANSI STANDARD- A156.5, GRADE 3

COMMERCIAL / RESIDENTIAL DEADBOLTS / DEAD LATCHES

- Optional Interchangeable Core for **Best, Falcon and Arrow**
- Optional Interchangeable Core for **Schlage Full Size** format

MEETS
The Buy American Act

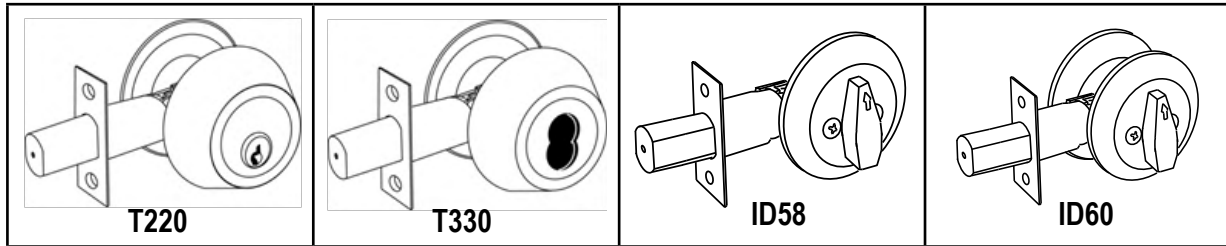

STOCK ITEM PRICES IN BOLD
NON-STOCK FINISHES AND DESIGNS AVAILABLE WITH FACTORY LEAD TIME AND SUBJECT TO MINIMUM ORDER

DESCRIPTION	ANSI	ITEM #	US3, 26D	US10B	US10	US15	US26	US32D	US5	US4	US1	PCS / MC
Standard Duty Single Cylinder Deadbolt	E0153	T220	\$63.90	\$68.37	\$68.37	\$68.37	\$68.37	\$63.90	\$68.37	\$68.37	\$68.37	20
		ICT220						63.90			68.37	
Standard Duty Double Cylinder Deadbolt	E0143	T330	85.20	89.67	89.67	89.67	89.67	85.20	89.67	89.67	89.67	20
		ICT330						85.20			89.67	

ICT (IC) Indicates functions available with Interchangeable Core. Cores are compatible 6 or 7 pin with **Best, Falcon and Arrow**. Prices do not include cores. For IC Core pricing see page L105. For Keying charges see page L115.



Standard Duty Single Cylinder Deadbolt With Schlage Big Format IC	E0153	SCICT220	88.08	94.15	94.15	94.15	94.15	88.08	94.15	94.15	---	20
Standard Duty Double Cylinder Deadbolt With Schlage Big Format IC	E0143	SCICT330	129.50	138.56	138.56	138.56	138.56	129.50	138.56	138.56	---	20

SCIC (SCIC) Indicates function available with Schlage full size format Interchangeable Core. Prices do not include cores. For IC Core pricing see page L106. For Keying charges see page L115.

Deadbolt thrown or retracted by turn unit only no outside trim. Bore halfway through door for installation visible from one side of door only	---	ID58	33.23	48.14	48.14	48.14	48.14	33.23	48.14	48.14	---	50
Deadbolt thrown or retracted by turn unit only. Blank plate is on external trim to be used on bore holes 1 3/8" and 2 1/4" wide	---	ID60	38.13	51.12	51.12	51.12	51.12	38.13	51.12	51.12	---	50

► **ADDITIONAL PARTS & CHARGES FOR STANDARD DUTY DEADBOLTS SERIES**

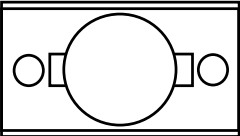
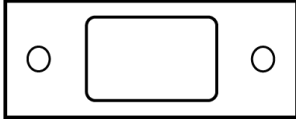
Backsets: 2 3/8", NO EXTRA CHARGE if ordered with lock only. Otherwise \$31.40 List Each.

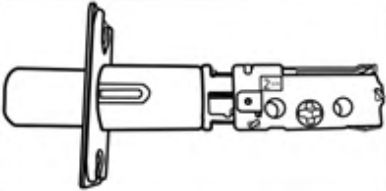
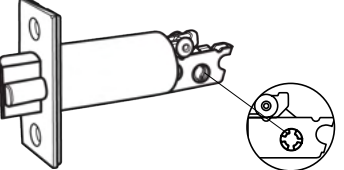
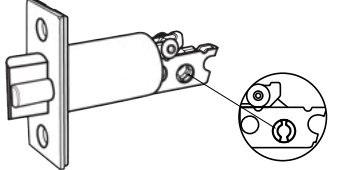
ILLUSTRATION	ITEM #	DESCRIPTION	FINISH	LIST PRICE
	LFA18	Latch front adapter to convert 1" Plate to 1 1/8" wide door preparations	CLEAR	\$0.71
	T2STRK	Deadbolt strike 1 1/8" x 2 3/4"	US3, 10B, 26D	4.98
	T22DRI-6	2 3/8" Drive-in Latch bolt for T220 / T330 Deadbolt	ZINC	29.39
	T22DRI-3	2 3/4" Drive-in Latch bolt for T220 / T330 Deadbolt		
	T220ADJ	2 3/8" - 2 3/4" Adjustable Latch bolt for T220 / T330 Deadbolt	US3, 10B, 26D	31.40
	GL238	2 3/8" backset gate latch and for double cylinder deadbolt		91.01
	GL234	2 3/4" backset gate latch and for double cylinder deadbolt		
	SINGL238	2 3/8" backset gate latch and for single cylinder deadbolt		
	SINGL234	2 3/4" backset gate latch and for single cylinder deadbolt		

► **PACKAGING INCLUDES**

- Standard "C" 6-pin cylinder.
- Adjustable 2 3/4" and 2 3/8" backset.
- Latch bolt size: 1" x 2 1/4".
- Latch front adapter is supplied in packaging to convert 1" faceplate for 1 1/8" wide door preparations.

► **KEYWAYS**

6-pin solid brass "C" keyway standard. Optional: Schlage E, Schlage C-K, Russwin D1-2-3-4, Corbin 59 / 60, Corbin-Russwin L4, Sargent LA-LB-LC, Falcon / Weiser E, Arrow A, Yale 8, Yale GA and Kwikset. Can also accept Medeco, Assa and Kaba High Security Cylinders. See page L115 for keying charges and Cylinder PART #.

● ► **IC CORES, KEYING CHARGES**

For IC Core pricing see pages L105 – L106. For Keying charges see page L115.

GATE LATCH DEAD LATCHES *Series List Price*

● Optional Interchangeable Core for **Best, Falcon and Arrow**

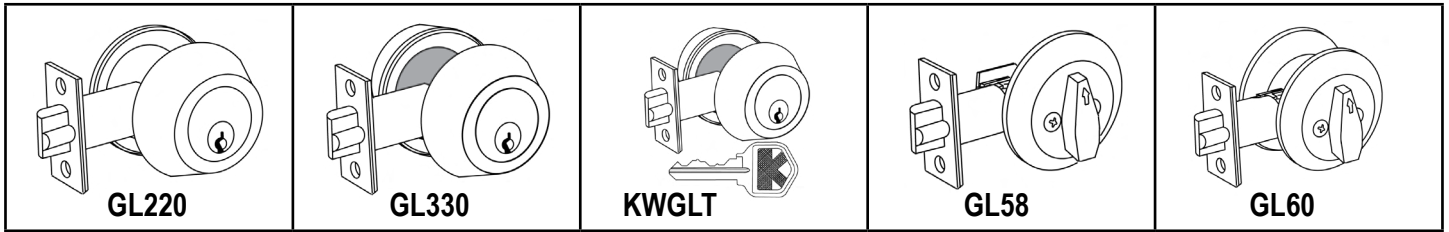

STOCK ITEM PRICES IN BOLD
NON-STOCK FINISHES AND DESIGNS AVAILABLE WITH FACTORY LEAD TIME AND SUBJECT TO MINIMUM ORDER

DESCRIPTION	ANSI	ITEM #	US3	US26D	US4	US10B	US10	US15	US26	US5	PCS / MC
Single Cylinder Gate Latch, "C" Keyway	E0153	GL220 ●ICGL220 (2 3/8" backset)	\$147.82	\$147.82	\$150.49	\$150.49	\$150.49	\$150.49	\$150.49	\$150.49	20
Single Cylinder Gate Latch, "C" Keyway	E0153	GL220234 ●GL220234 (2 3/4" backset)	147.82	147.82	150.49	150.49	150.49	150.49	150.49	150.49	
Single Cylinder Gate Latch, Kwikset Keyway	E0153	KWGLT220 (2 3/8" backset)	147.82	147.82	150.49	150.49	150.49	150.49	150.49	150.49	
Single Cylinder Gate Latch, Kwikset Keyway	E0153	KWGLT220234 (2 3/4" backset)	147.82	147.82	150.49	150.49	150.49	150.49	150.49	150.49	
Double Cylinder Gate Latch, "C" Keyway	E0143	GL330 ●ICGL330 (2 3/8" backset)	168.91	168.91	171.57	171.57	171.57	171.57	171.57	171.57	
Double Cylinder Gate Latch, "C" Keyway	E0143	GL330234 ●GL330234 (2 3/4" backset)	168.91	168.91	171.57	171.57	171.57	171.57	171.57	171.57	
Double Cylinder Gate Latch, Kwikset Keyway	E0143	KWGLT330 (2 3/8" backset)	168.91	168.91	171.57	171.57	171.57	171.57	171.57	171.57	
Double Cylinder Gate Latch, Kwikset Keyway	E0143	KWGLT330234 (2 3/4" backset)	168.91	168.91	171.57	171.57	171.57	171.57	171.57	171.57	

● (IC) Indicates functions available with Interchangeable Core. Cores are compatible 6 or 7 pin with **Best, Falcon and Arrow**.
Prices do not include cores. For IC Core pricing see pages L105 – L106. For Keying charges see page L115.

STOCK ITEM PRICES IN BOLD

NON-STOCK FINISHES AND DESIGNS AVAILABLE WITH FACTORY LEAD TIME AND SUBJECT TO MINIMUM ORDER

DESCRIPTION	ITEM #	US3	US26D	US4	US10B	US10	US15	US26	US5	PCS / MC
Gate latch retracted by turn unit only no outside trim. Bore halfway through door for installation visible from one side of door only.	GL58 (2 3/8" backset)	\$116.19	\$116.19	\$129.29	\$129.29	\$129.29	\$129.29	\$129.29	\$129.29	50
Gate latch retracted by turn unit only. Blank plate is on external trim to be used on bore holes 1 5/8" x and 2 1/8" wide.	GL60 (2 3/8" backset)	121.41	121.41	134.62	134.62	134.62	134.62	134.62	134.62	
Gate latch retracted by turn unit only no outside trim. Bore halfway through door for installation visible from one side of door only.	GL58234 (2 3/4" backset)	116.19	116.19	129.29	129.29	129.29	129.29	129.29	129.29	
Gate latch retracted by turn unit only. Blank plate is on external trim to be used on bore holes 1 5/8" x and 2 1/8" wide.	GL60234 (2 3/4" backset)	121.41	121.41	134.62	134.62	134.62	134.62	134.62	134.62	

► PACKAGING INCLUDES

- Standard "C" 6-pin cylinder or Kwikset KW
- Standard 2 3/8" backset or 2 3/4". Specify backset.
- Latch bolt size: 1 1/8" x 2 1/4"
- Strike size: 1 1/8" x 2 3/4"

► IC CORES, KEYING CHARGES

For IC Core pricing see pages L105 – L106.
For Keying charges see page L115.

► KEYWAYS

6-pin solid brass "C" keyway standard.

► ADDITIONAL PARTS & CHARGES FOR GATE LATCH DEAD LATCHES SERIES

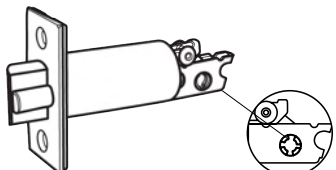
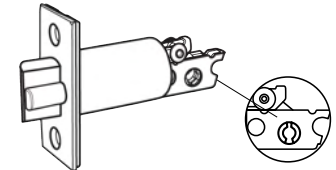
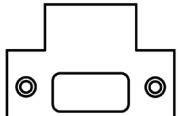
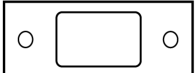
ILLUSTRATION	ITEM #	DESCRIPTION	FINISH	LIST PRICE
	GL238	2 3/8" backset gate latch and for double cylinder deadbolt	US3, 10B, 26D	\$91.01
	GL234	2 3/4" backset gate latch and for double cylinder deadbolt		
	SINGL238	2 3/8" backset gate latch and for single cylinder deadbolt		
	SINGL234	2 3/4" backset gate latch and for single cylinder deadbolt		
	TS	T-Strike	US3, 26D, 10B, 26, 4, 10, 15	5.33
	T2STRK	Deadbolt Strike 1 1/8" X 2 3/4"	US3, 10B, 26D	4.98

LSD Series List Price

LIGHT COMMERCIAL/RESIDENTIAL

STANDARD DUTY DEADBOLTS, ANSI Grade 3

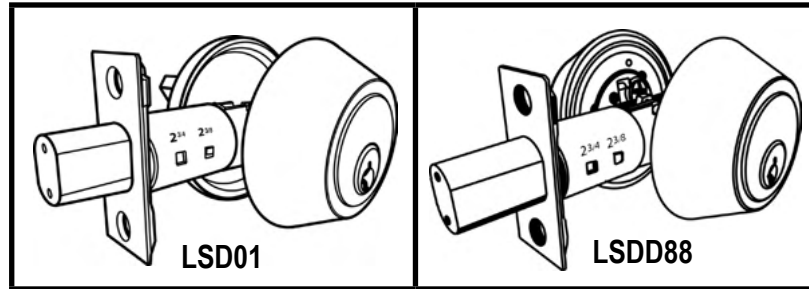

STOCK ITEM PRICES IN BOLD
NON-STOCK FINISHES AND DESIGNS AVAILABLE WITH FACTORY LEAD TIME
AND SUBJECT TO MINIMUM ORDER

DESCRIPTION	ANSI	ITEM #	US3, 26D, US32D	US10B, 5, 15	US32	PCS / MC
Standard Duty Single Cylinder Deadbolt	E0153	LSD01	\$42.28	\$48.14	\$48.14	36
Standard Duty Double Cylinder Deadbolt	E0143	LSDD88	48.14	55.27	55.27	36

► **PACKAGING INCLUDES**

- Standard "C" 6-pin cylinder
- Adjustable 2 3/4" and 2 3/8" backset
- Latch: Backset latch size 1" x 2 1/4" faceplate. Latch front adapter is available to convert 1" face plate for 1 1/8" wide door preparations. See below.
- Strike size: 1 1/8" x 2 3/4"

► **KEYWAYS**

6-pin solid brass "C" keyway standard. Optional: Schlage E, Schlage C-K, Russwin D1-2-3-4, Corbin 59 / 60, Corbin-Russwin L4, Sargent LA-LB-LC, Falcon / Weiser E, Arrow A, Yale 8, Yale GA and Kwikset. Can also accept Medeco, Assa, Kaba and **Cal-Royal HSK** High Security Cylinders. See **page L115** for keying charges and Cylinder PART #.

► **KEYING CHARGES**

Refer to page L115

► **ADDITIONAL PARTS**

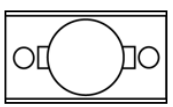
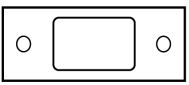
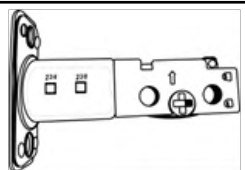
ILLUSTRATION	ITEM #	DESCRIPTION	FINISH	LIST PRICE
	LFA18	Latch front adapter to convert 1" face plate to 1 1/8" wide door preparations	CLEAR	\$0.71
	T2STRK	Deadbolt strike 1 1/8" X 2 3/4"	US3, 10B, 26D	4.98
	ED500ADJ	ED500 Adjustable Latch bolt, round corner 1" X 2 1/4"	US3, 10B, 26D	14.93

IND84 Indicator Deadbolts Series List Price

COMMERCIAL / RESIDENTIAL INDICATOR DEADBOLTS 3

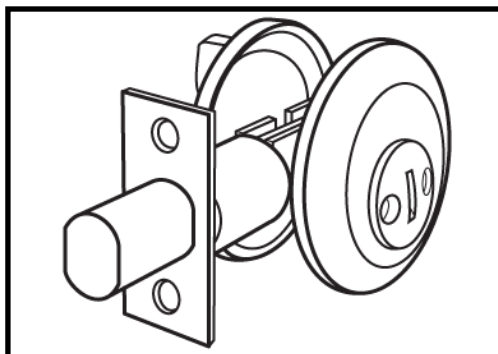



STOCK ITEM PRICES IN BOLD
NON-STOCK FINISHES AND DESIGNS AVAILABLE WITH FACTORY LEAD TIME
AND SUBJECT TO MINIMUM ORDER

ITEM #	DESCRIPTION	US3, 4, 26D	US10B	PCS/ MC
IND84	Indicator Deadbolt	\$72.85	\$78.70	36

► **PACKAGING INCLUDES**

- Adjustable 2 3/4" and 2 3/8" backset
- Latch: Backset latch size 1" x 2 1/4" faceplate. Latch front adapter is provided to convert 1" face plate for 1 1/8" wide door preparations. See below.
- Strike size: 1 1/8" x 2 3/4"

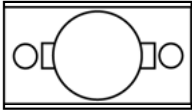
► **ADDITIONAL PARTS & CHARGES**

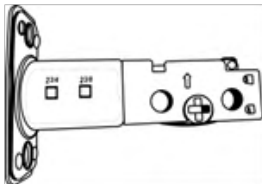
ILLUSTRATION	ITEM #	DESCRIPTION	FINISH	LIST PRICE
	LFA18	Latch front adapter to convert 1" face plate to 1 1/8" wide door preparations	CLEAR	0.71
	T2STRK	Deadbolt strike 1 1/8" X 2 3/4"	US3, 10B, 26D	4.98
	ED500ADJ	ED500 Adjustable Latch bolt, round corner 1" X 2 1/4"	US3, 10B, 26D	14.93

ASHLEY Series List Price

RESIDENTIAL TUBULAR LOCKSETS AND LEVERSETS

ANSI STANDARD A156.2, GRADE 3

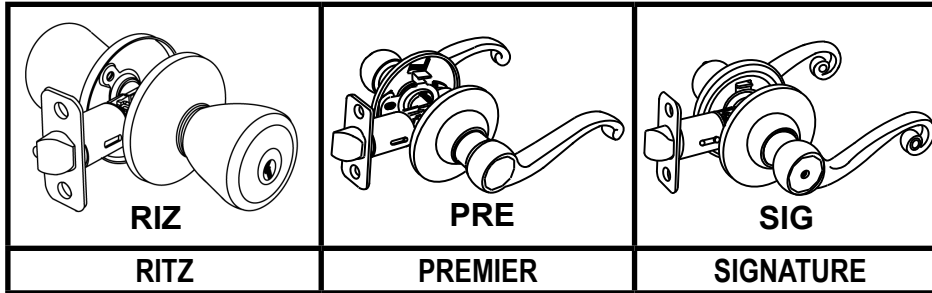

► KEYWAYS KW 5-PIN KWIKSET

STOCK ITEM PRICES IN BOLD
 NON-STOCK FINISHES AND DESIGNS AVAILABLE WITH FACTORY LEAD TIME
 AND SUBJECT TO MINIMUM ORDER

► KNOB DESIGNS

RITZ ----- RIZ SERIES

FUNCTIONS	ANSI	ITEM #	US3	US26D	US5	US15	US4, 15A, 10B	US26	PCS / MC
Entry KA / 3	F109	RIZ00	\$40.79	\$40.79	\$44.73	\$44.73	\$44.73	\$44.73	36
Storeroom KD	F86	RIZ05		40.79	44.73	44.73	44.73	44.73	
Privacy	F76	RIZ20	33.34	33.34	37.28	37.28	37.28		
Bathroom split	F76	RIZ20 / 26	33.34	33.34	37.28	----	33.34	----	
Passage	F75	RIZ30	32.06	32.06	35.89	35.89	35.89	35.89	
Dummy	----	RIZ40	12.67	12.678	14.27	14.27	14.27	14.27	

► LEVERSET DESIGNS

PREMIER ----- PRE SERIES

FUNCTIONS	ANSI	ITEM #	US3, 26D	US15	US10B	US26, 15A	US5	US4	PCS / MC
Entry KD Lever / Lever *SH	F109	LEPRE00	\$53.68	\$53.68	\$55.91	\$56.77	\$56.77	\$56.77	24
Privacy *SH	F76	PRE20	50.48	54.95	53.36	54.42	54.42	54.42	
Bathroom split *SH	F76	PRE20 / 26		----	----	54.42	54.42	54.42	
Passage *SH	F75	PRE30	48.56	48.56	50.38	52.40	52.40	52.40	
Dummy *SH	----	PRE40	23.96	23.96	28.76	25.88	25.88	25.88	36

*SH is for specify handing

SIGNATURE ----- SIG SERIES

FUNCTIONS	ANSI	ITEM #	US3	US26D	US5	US4,15A, 15,10B	US26	PCS / MC
Entry KD Lever / Lever *SH	F109	LESIG00	\$53.68	\$53.68	\$28.25	\$60.17	\$60.17	24
Privacy *SH	F76	SIG20	50.48	50.48	54.42	54.42	54.42	
Bathroom split *SH	F76	SIG20 / 26		54.42	54.42	----	----	
Passage *SH	F75	SIG30	50.48	50.48	52.40	52.40	52.40	
Dummy *SH	----	SIG40	23.96	23.96	25.88	25.88	25.88	36

*SH is for specify handing

Premier and Signature Series are reversible non-handed except **LESIG00**. Specify handing for convenience. If handing is not available at time of shipment opposite hand will be supplied.

► **PACKAGING INCLUDES**

- Adjustable steel 2 3/8" and 2 3/4" backset (2 1/4" x 1", 1/4" radius). Drive in latch bolt also available on request. Square corner available on request on special factory order with lead time and subject to minimum quantity.
- All locksets are packed with full lip strike round corner 1/4" radius.
- Square corner available on request.
- Kwikset rekeyable 5-pin cylinder.

► **ADDITIONAL PARTS & CHARGES FOR ASHLEY SERIES**

ITEM #	DESCRIPTION	LIST PRICE
DRESADJ	Entrance four way adjustable drive-in latch bolt, square corner	\$11.14
SRESADJ	Privacy, passage four way adjustable drive-in latch bolt, square corner	
ASHADJ	Entrance standard adjustable latch bolt, round corner 1" x 2 1/4"	
TS	T-Strike	5.33
FLS	Full lip strike	
ASAST US3, 26D, 26	ANSI ASA strike	5.33
ASAST US10B, 10		7.47
EXASA-175 US32D, DURO	Extended Lip ANSI Strike, 1 3/4" Lip Extension from Screw Center Line	44.91
K1-KEY	Blank keys K1	1.66
KEYS	Extra cut keys	3.91
CRT800	Cylinder removal tool	2.02
LFA18	Latch front adapter to convert 1" faceplate to 1 1/8" wide door preparation	0.71
PDBFLS	Plastic Dust box for Full Lip Strike	3.32
PDB1214	Plastic Dust box for Residential Deadbolt Strike 1" x 2 1/4"	
PDB118234	Plastic Dust box for T-Strike 1 1/8" x 2 3/4"	
PDBTS	Plastic Dust box for Deadbolt T2STRK Strike	
PDB478	Plastic Dust box for ASA Strike	6.52
KEYING KITS		
KKWI200	Keying Kit - KWI Keyway	282.03
MOUNT		
RESMOUNT	3 hole mount for residential locks	173.01

► **KEYING CHARGES**

ITEM #	DESCRIPTION	LIST PRICE
KARES	Key Alike	5.81
MKRES	Master Key (Including KA Charges)	7.35
CMKRES	Builder Construction Master Key (Including KA & MK Charges)	10.19
GMKRES	Grand Master Key (Including KA, MK & CMK Charges)	13.15

CHELSIE Series List Price

RESIDENTIAL TUBULAR LOCKSETS, DEADBOLTS, LEVERS AND HANDLESETS, ANSI STANDARD A156.2, GRADE 3

- ▶ **KEYWAYS (STD, "KW" 5-PIN KWIKSET) OPTIONAL 5-PIN SCHLAGE "C" & WEISER**
 - All locksets, handle sets and deadbolts are available with Schlage "C" and Weiser keyway on special factory order only, with no additional charge. Consult factory.
 - **SCHLAGE "C" KEYWAY OPTION:** For immediate stock shipment add **\$8.21 List** for keyed entrance lock and single cylinder deadbolts. Prefix C before Part # (Ex: REN00 with C keyway is CREN00)
 - **WEISER KEYWAY OPTION:** For keyed knob and leversets add **\$5.22 List**. For Single Cylinder Deadbolts, add **\$7.77 List** and for Double Cylinder Deadbolts add **\$15.43 List**. Prefix "W" before Part # (Ex: REN00 with Weiser keyway is WREN00)

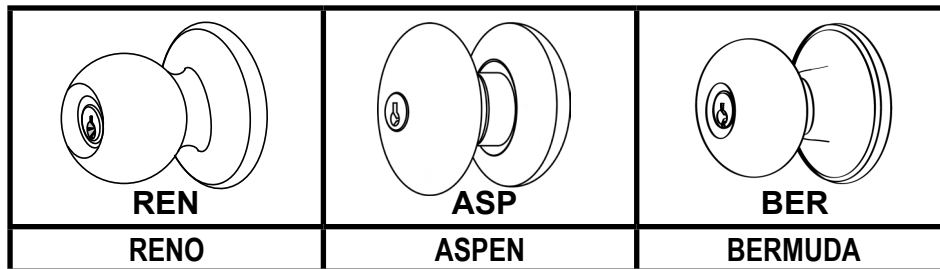

STOCK ITEM PRICES IN BOLD
NON-STOCK FINISHES AND DESIGNS AVAILABLE WITH FACTORY LEAD TIME
AND SUBJECT TO MINIMUM ORDER

RENO ----- REN DESIGN

FUNCTIONS	ANSI	ITEM #	US15	US10B	US3, 26D, 32D	US5, US26	US15A	PCS / MC
Entry - KA / 3	F109	REN-00	\$39.09	\$45.69	\$39.09	\$43.03	\$43.03	36
Storeroom - KA / 3	F86	REN-05 ^{stock}						
Privacy	F76	REN-20	32.59	39.09	32.59	35.89	35.89	
Passage	F75	REN-30	30.57	37.17	30.57	33.55	33.55	
Dummy	----	REN-40	13.53	20.13	13.53	14.80	14.80	

 Prefix "UL" before Part # when ordering UL Listed, available on Entrance and Passage functions. Add \$7.47 List.
***REN05 US26 Non-Stock

ASPEN ----- ASP DESIGN

FUNCTIONS	ANSI	ITEM #	US3	US15	US10B	US5, 15A, 26, 26D	PCS / MC
Entry - KA / 3	F109	ASP-00	\$45.69	\$52.19	\$58.79	\$52.19	36
Storeroom - KA / 3	F86	ASP-05					
Privacy	F76	ASP-20	39.09	45.69	52.19	45.69	
Passage	F75	ASP-30	37.17	43.67	50.27	43.67	
Dummy	----	ASP-40	20.13	23.32	29.93	23.32	



 Prefix "UL" before Part # when ordering UL Listed, available on Entrance and Passage functions. Add \$7.47 List.

BERMUDA ----- BER DESIGN

FUNCTIONS	ANSI	ITEM #	US3	US15	US10B	US5, 15A, 26, 26D	PCS / MC
Entry - KA / 3	F109	BER-00	\$42.39	\$45.69	\$54.85	\$45.69	36
Storeroom - KA / 3	F86	BER-05					
Privacy	F76	BER-20	34.51	37.81	45.69	37.81	
Passage	F75	BER-30	32.59	35.89	43.03	35.89	
Dummy	----	BER-40	14.80	16.19	19.38	16.19	

 Prefix "UL" before Part # when ordering UL Listed, available on Entrance and Passage functions. Add \$7.47 List.

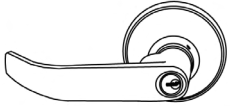
► **CHELSEIE SERIES LEVERSET DESIGNS**

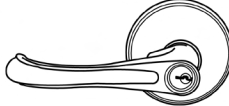
 MAY	 SOP	 LEN	 BRI	 AUS
MAYFAIR	SOPHIA	LENOX	BRISTOL	AUSTIN

MAYFAIR ----- MAY DESIGN

FUNCTIONS	ANSI	ITEM #	US3, 15	US10B	US26D	US5	US15A, 26	PCS / MC
Entry - KA / 3 *SH	F109	MAY-00	\$48.99	\$55.49	\$48.99	\$53.89	\$53.89	24
Storeroom - KA / 3 *SH	F86	MAY-05						
Privacy *SH	F76	MAY-20	44.30	50.91	44.30	48.99	48.99	
Passage *SH	F75	MAY-30	42.39	48.99	42.39	46.65	46.65	
Active Dummy *SH	----	MAY-40	21.41	28.01	21.41	23.64	23.64	36

 Prefix "UL" before Part # when ordering UL Listed, available on Entrance and Passage functions. Add \$7.47 List.
* SH is for Specify Handing

SOPHIA ----- SOP DESIGN

FUNCTIONS	ANSI	ITEM #	US3, 15	US10B	US26D	US5, 15A, 26	PCS / MC
Entry - KA / 3	F109	SOP-00	\$48.99	\$55.49	\$48.99	\$53.89	24
Storeroom - KA / 3	F86	SOP-05					
Privacy	F76	SOP-20	44.30	50.91	44.30	48.99	
Passage	F75	SOP-30	42.39	48.99	42.39	46.65	
Active Dummy	----	SOP-40	21.41	28.01	21.41	23.64	36

 Prefix "UL" before Part # when ordering UL Listed, available on Entrance and Passage functions. Add \$7.47 List.

LENOX ----- LEN DESIGN

FUNCTIONS	ANSI	ITEM #	US3, 15	US10B	US26D	US5, 26	US15A	PCS / MC
Entry - KA / 3	F109	LEN-00	\$48.99	\$55.49	\$48.99	\$53.89	\$53.89	24
Storeroom - KA / 3	F86	LEN-05						
Privacy	F76	LEN-20	44.30	50.91	44.30	48.99	48.99	
Passage	F75	LEN-30	42.39	48.99	42.39	46.65	46.65	
Active Dummy	----	LEN-40	21.41	28.01	21.41	23.64	23.64	36

 Prefix "UL" before Part # when ordering UL Listed, available on Entrance and Passage functions. Add \$7.47 List.

BRISTOL ----- BRI DESIGN

FUNCTIONS	ANSI	ITEM #	US15	US10B	US3, 26D	US5, 15A, 26	PCS / MC
Entry - KA / 3	F109	BRI-00	\$48.99	\$55.49	\$48.99	\$58.79	24
Storeroom - KA / 3	F86	BRI-05					
Privacy	F76	BRI-20	44.30	50.91	44.30	48.99	
Passage	F75	BRI-30	42.39	48.99	42.39	46.65	
Active Dummy	----	BRI-40	21.41	28.01	21.41	23.64	36

 Prefix "UL" before Part # when ordering UL Listed, available on Entrance and Passage functions. Add \$7.47 List.

AUSTIN ----- AUS DESIGN

FUNCTIONS	ANSI	ITEM #	US3, 15	US10B	US5	US26D	US15A, 26	PCS / MC
Entry - KA / 3	F109	AUS-00	\$48.99	\$55.49	\$53.25	\$53.89	\$53.89	24
Storeroom - KA / 3	F86	AUS-05						
Privacy	F76	AUS-20	44.30	50.91	48.99	48.99	48.99	
Passage	F75	AUS-30	42.39	48.99	46.65	46.65	46.65	
Active Dummy	----	AUS-40	21.41	28.01	23.64	23.64	23.64	36





 Prefix "UL" before Part # when ordering UL Listed, available on Entrance and Passage functions. Add \$7.47 List.

► **LEVERSET PACKAGING INCLUDES**

- Adjustable steel 2 3/8" and 2 3/4" backset (2 1/4" x 1", 1/4" radius). Drive in latch bolt also available on request. Square corner available on request on special factory order with lead time and subject to minimum quantity.
- All locksets are packed with full lip strike round corner 1/4" radius. Square corner available on request.
- Kwikset rekeyable 5 pin cylinder.

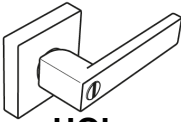
CONTEMPORARY Series List Price

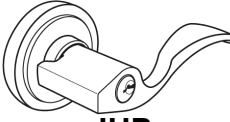
RESIDENTIAL LEVERS, ANSI STANDARD A156.2, GRADE 3

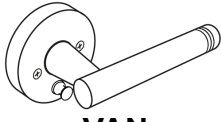
 HOL	 ATL	 JUP	 PHO	 VAN
HOLLAND	ATLAS	JUPITER	PHOENIX	VANITY

STOCK ITEM PRICES IN BOLD
NON-STOCK FINISHES AND DESIGNS AVAILABLE WITH FACTORY LEAD TIME AND SUBJECT TO MINIMUM ORDER.

HOLLAND ----- HOL DESIGN

FUNCTIONS	ANSI	ITEM #	US15	US10B	US3, 26D	US5, 15A, 26	PCS / MC	
Entry - KA / 3	*NH	F109	HOL-00	\$99.68	\$106.40	\$99.68	\$106.40	20
Privacy	*NH	F76	HOL-20	95.32	101.92	95.32	101.92	
Passage	*NH	F75	HOL-30	90.85	97.55	90.85	97.55	
Dummy	*NH	----	HOL-40	44.30	48.78	44.30	48.78	36

* NH is for Non-Handed (Reversible) **NOT AVAILABLE WITH UL LATCH** ☒

ATLAS ----- ATL DESIGN

FUNCTIONS	ANSI	ITEM #	US15	US10B	US3, 26D	US5, 15A, 26	PCS / MC	
Privacy	*H	F76	ATL20	\$90.85	\$97.55	\$90.85	\$97.55	20
Passage	*NH	F75	ATL30	86.48	93.08	86.48	93.08	
Dummy	*NH	----	ATL40	42.17	46.54	42.17	46.54	36

* NH is for Non-Handed (Reversible) **NOT AVAILABLE WITH UL LATCH** ☒

* H is for Handed (Order Handling for Convenience)

JUPITER ----- JUP DESIGN

FUNCTIONS	ANSI	ITEM #	US15	US10B	US3, 26D	US5, 15A, 26	PCS / MC	
Entry - KA / 3	*H	F109	JUP-00	\$79.77	\$84.24	\$79.77	\$84.24	20
Privacy	*H	F76	JUP-20	75.40	79.77	75.40	79.77	
Passage	*H	F75	JUP-30	68.69	73.17	68.69	73.17	
Dummy	*H	----	JUP-40	39.94	44.30	39.94	44.30	36

* H is for Handed (Order Handling for Convenience) **NOT AVAILABLE WITH UL LATCH** ☒

PHOENIX ----- PHO DESIGN

FUNCTIONS	ANSI	ITEM #	US15	US10B	US3, 26D	US5, 15A, 26	PCS / MC	
Entry - KA / 3	*H	F109	PHO-00	\$99.68	\$106.39	\$99.68	\$106.39	20
Privacy	*H	F76	PHO-20	95.32	101.92	95.32	101.92	
Passage	*H	F75	PHO-30	90.85	97.55	90.85	97.55	
Dummy	*H	----	PHO-40	44.30	48.78	44.30	48.78	36

* H is for Handed (Order Handling for Convenience) **NOT AVAILABLE WITH UL LATCH** ☒

VANITY ----- VAN DESIGN

FUNCTIONS	ANSI	ITEM #	US15	US10B	US3, 26D	US5, 15A, 26	PCS / MC	
Privacy	*H	F76	VAN-20	\$90.85	\$97.55	\$90.85	\$97.55	20
Passage	*NH	F75	VAN-30	86.48	93.08	86.48	93.08	
Dummy	*NH	----	VAN-40	42.17	46.54	42.17	46.54	36

* NH is for Non-Handed (Reversible) **NOT AVAILABLE WITH UL LATCH** ☒

* H is for Handed (Order Handling for Convenience)

SUMMIT Series List Price

WITH PUSH BUTTON LOCKING MECHANISM AND AUTO RELEASE FEATURE, ANSI STANDARD A156.2, GRADE 3

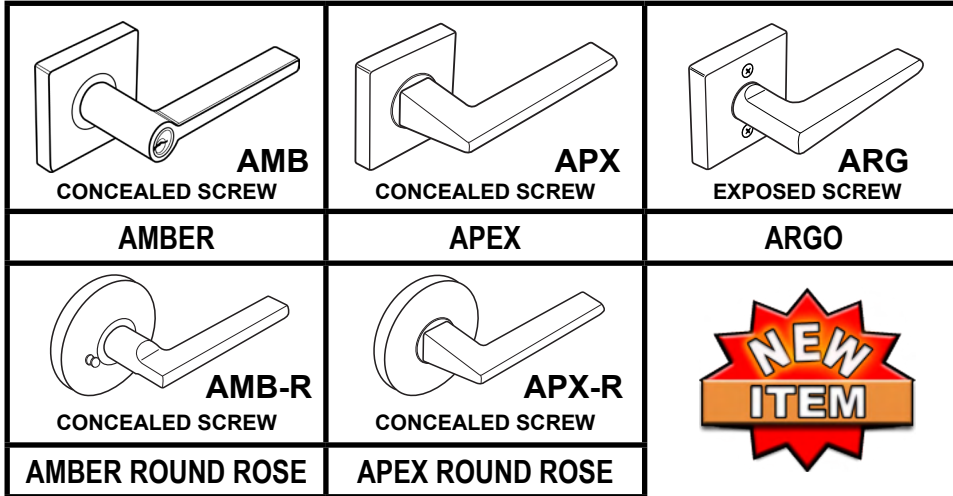

**ALL DESIGNS HAVE
PUSH BUTTON
LOCKING MECHANISM
& AUTO RELEASE
FOR IMMEDIATE EGRESS,
PANIC EXIT STRUCTURE
ON PRIVACY FUNCTIONS.
KEYED ENTRY FOR
AMBER DESIGN ONLY.**

STOCK ITEM PRICES IN BOLD
NON-STOCK FINISHES AND DESIGNS AVAILABLE WITH FACTORY LEAD TIME AND SUBJECT TO MINIMUM ORDER

AMBER ----- AMB SERIES

FUNCTIONS	ANSI	ITEM #	US15	US26	US10B	US3, 26D	US5, 15A	PCS / MC
Entrance *NH	---	AMB-00	\$113.00	\$117.47	\$117.47	\$113.00	\$113.00	20
Privacy *NH	F76	AMB-20	95.32	99.68	99.68	95.32	99.68	
Passage *NH	F75	AMB-30	90.85	95.32	95.32	90.85	95.32	
Dummy *NH	---	AMB-40	44.30	48.78	48.78	44.30	48.78	36

Comes standard with Square Rose. Add Suffix "R" after Part # for Round Rose option.

For Example: To order **AMB-20 US15** with Round Rose, use "**AMB-20R US15**" when ordering.

* NH is for Non-Handed **NOT AVAILABLE WITH UL LATCH** ☒

APEX ----- APX SERIES

FUNCTIONS	ANSI	ITEM #	US15	US26	US10B	US3, 26D	US5, 15A	PCS / MC
Privacy *NH	F76	APX-20	95.32	99.68	99.68	95.32	99.68	20
Passage *NH	F75	APX-30	90.85	95.32	95.32	90.85	95.32	
Dummy *NH	---	APX-40	44.30	48.78	48.78	44.30	48.78	36

Comes standard with Square Rose. Add Suffix "R" after Part # for Round Rose option.

For Example: To order **APX-20 US15** with Round Rose, use "**APX-20R US15**" when ordering.

* NH is for Non-Handed **NOT AVAILABLE WITH UL LATCH** ☒





ARGO ----- ARG SERIES

FUNCTIONS	ANSI	ITEM #	US15	US26	US10B	US3, 26D	US5, 15A	PCS / MC
Privacy *NH	F76	ARG-20	\$90.85	\$97.55	\$99.68	\$90.85	\$97.55	20
Passage *NH	F75	ARG-30	86.48	93.08	95.32	86.48	93.08	
Dummy *NH	---	ARG-40	42.17	46.54	48.78	42.17	46.54	36

Comes standard with Square Rose.

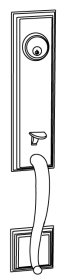
* NH is for Non-Handed **NOT AVAILABLE WITH UL LATCH** ☒

► **CHELSEIE SERIES HANDLESET DESIGNS**

 MER	 SAV	 CAM	 BAB	 DEE
MERIDIAN	SAVANNAH	CAMBRIDGE	BAYBRIDGE	DEERFIELD

STOCK ITEM PRICES IN BOLD
NON-STOCK FINISHES AND DESIGNS AVAILABLE WITH FACTORY LEAD TIME AND SUBJECT TO MINIMUM ORDER

MERIDIAN ----- MER DESIGN

FUNCTIONS	ITEM #	PVD US3	US10B	US5,15, 15A, 26	PCS / MC
Solid Brass Handle with single cylinder deadbolt KD	MER00	\$332.92	\$332.92	\$304.91	10
Dummy handle set with dummy deadbolt and matching trim	MER40	317.37	317.37	289.36	

*** All prices above on the **MER Design** are for any design on knobs and lever sets for interior handle. **PRE Premier Design** is not available for interior handleset. All other trims designs are available. On **Chelsie Series** specify at time of order (Ex: MER00 / REN)

SAVANNAH ----- SAV DESIGN

FUNCTIONS	ITEM #	PVD US3	US10B	US5,15, 15A, 26	PCS / MC
Solid Brass Handle with single cylinder deadbolt KD	SAV00	\$332.92	\$332.92	\$304.91	10
Dummy handle set with dummy deadbolt and matching trim	SAV40	317.37	317.37	289.36	

*** All prices above on the **SAV Series** are for any design on knobs and lever sets for interior handle. **SIG Signature / PRE Premier Designs** are not available for interior handleset. All other trims designs are available. On **Chelsie Series** specify at time of order (Ex: SAV00 / REN)

CAMBRIDGE ----- CAM DESIGN

FUNCTIONS	ITEM #	PVD US3	US10B	US5,15, 15A, 26	PCS / MC
Solid Brass Handle with single cylinder deadbolt KD	CAM00	\$320.14	\$320.14	\$274.45	10
Dummy handle set with dummy deadbolt and matching trim	CAM40	303.85	303.85	261.35	

*** All prices above on the **CAM Design** are for any design on knobs and lever sets for interior handle. **PRE Premier Design** is not available for interior handleset. All other trims designs are available. On **Chelsie Series** specify at time of order (Ex: CAM00 / REN)

BAYBRIDGE ----- BAB DESIGN

FUNCTIONS	ITEM #	US15, 15A, 26	US10B	US3, 26D	US5	PCS / MC
Handle w/ single cylinder deadbolt	BAB-00	\$232.38	\$275.94	\$210.55	\$232.38	10
Dummy handle set with dummy deadbolt and matching trim	BAB-40	217.79	261.35	196.07	217.79	

*** All prices above on the **BAB Design** are for design knob for interior handle. **PRE Premier and SIG Signature Designs** are not available for interior handleset. All other trims designs are available. Specify at time of order (Ex: BAB00 / LENTRIM is BAB00 with LEN lever design on interior.)

DEERFIELD ----- DEE DESIGN

FUNCTIONS	ITEM #	US3	US15	US10B	US5, 15A, 26	US26D	PCS / MC
Handle with single cylinder deadbolt	DEE-00	\$232.38	\$254.11	\$297.77	\$254.11	\$254.11	10
Dummy handle set with dummy deadbolt and matching trim	DEE-40	217.79	239.63	283.18	239.63	239.63	

*** All prices above on the **DEE Design** are for design knob for interior handle. **PRE Premier and SIG Signature Designs** are not available for interior handleset. All other trims designs are available. Specify at time of order (Ex: DEE00 / LENTRIM is DEE00 with LEN lever design on interior.)

► **CONTEMPORARY SERIES (ESQ DESIGN), AND CHELSIE SERIES DEADBOLT DESIGNS**

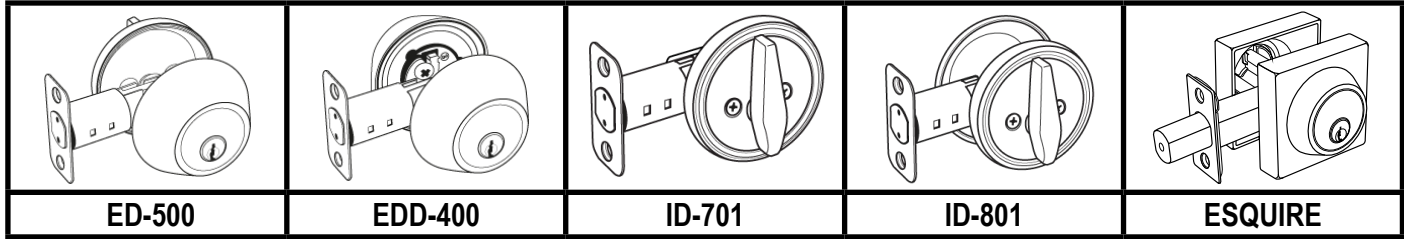

STOCK ITEM PRICES IN BOLD
NON-STOCK FINISHES AND DESIGNS AVAILABLE WITH FACTORY LEAD TIME AND SUBJECT TO MINIMUM ORDER

FUNCTIONS	ITEM #	US3	US15	US26D	US10B	US15A	US32D	US5	US26	PCS / MC
Single cylinder deadbolt	ED-500	\$35.36	\$35.36	\$35.36	\$41.64	\$38.45	\$35.36	\$38.45	\$38.45	36
Single cylinder deadbolt (UL)	ULED-500	47.82	47.82	47.82	54.10	51.01	48.78	51.01	51.01	
Square single cylinder deadbolt	ESQ-101	53.25	53.25	53.25	57.62	57.62	---	57.62	57.62	
Square double cylinder deadbolt	ESQ-102	68.69	68.69	68.69	73.17	73.17	---	73.17	73.17	
Double cylinder deadbolt	EDD-400	40.36	40.36	40.36	46.65	46.65	40.36	46.65	46.65	
One sided deadbolt	ID-701	19.81	23.22	23.22	27.80	23.22	23.22	23.22	23.22	
One sided deadbolt with exterior cover plate	ID-801	25.77	29.39	29.39	34.19	29.39	25.67	29.39	29.39	

► **DEADBOLT AND HANDLESET PACKAGING INCLUDES:**

- Adjustable steel 2 3/8" and 2 3/4" backset (2 1/4" x 1", 1/4" radius). Drive in latch bolt also available on request. Square corner available upon request on special factory order with lead time.
- Deadbolts packed with 1" x 2 1/4" strike round corner 1/4" radius and full lip strike 1/4" radius. Square corner available upon request. On special factory order with lead time.



Security strike (1 1/4" x 3 5/8", 1/4" radius) with 3" screws available with an additional charge.

➤ Kwikset rekeyable 5 pin cylinder.

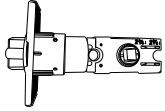
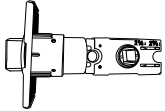
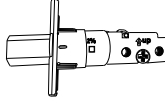
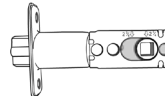
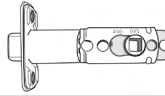
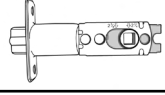
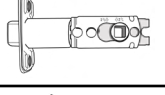
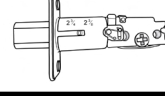
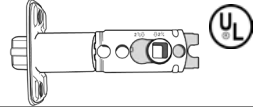
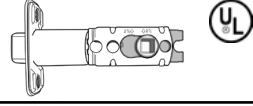
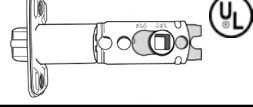
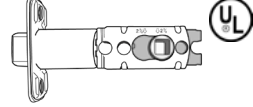
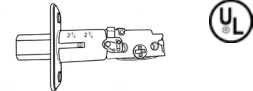
➤ **ADDITIONAL PARTS & CHARGES FOR CHELSIE, CONTEMPORARY, AND SUMMIT SERIES**

ILLUSTRATION	ITEM #	DESCRIPTION	LIST PRICE
	4DRIVE2-1	Entrance Four Way Adjustable Drive In Latch bolt, with removable Square Corner faceplate for knobsets	\$11.14
	4DRIVE2-2	Entrance Four Way Adjustable Drive In Latch bolt, with removable Square Corner faceplate for leversets	
	4DRIVP2-1	Privacy, Passage Four Way Adjustable Drive In Latch bolt, with removable Square Corner faceplate for knobsets	
	4DRIVP2-2	Privacy, Passage Four Way Adjustable Drive In Latch bolt, with removable Square Corner faceplate for knobsets	
	4DRIV31	Deadbolt Four Way Adjustable Drive-In Latch bolt, with removable Square Corner faceplate	14.93
	ENTK-4	Adjustable Dead Latch 2 3/8" or 2 3/4" with round corner faceplate for Entrance Knobsets	11.14
	PASK-6	Adjustable Spring Latch 2 3/8" or 2 3/4" with round corner faceplate for Passage Knobsets	11.14
	ENTL-5	Adjustable Dead Latch 2 3/8" or 2 3/4" with round corner faceplate for Entrance Leversets	11.14
	PASL-7	Adjustable Spring Latch 2 3/8" or 2 3/4" with round corner faceplate for Passage Leversets	11.14
	DB-8	Adjustable Deadbolt Latch 2 3/8" or 2 3/4" for Deadbolts	14.93
FOR USE with UL-Listed Chelsie Series Leversets and Deadbolts ONLY (MAY, SOP, LEN, BRI, AUS and ULED-500)			
	ULENK-4	UL-Listed Adjustable Dead Latch 2 3/8" or 2 3/4" with round corner faceplate for Entrance Knobsets	17.66
	ULPASK-6	UL-Listed Adjustable Spring Latch 2 3/8" or 2 3/4" with round corner faceplate for Passage Knobsets	17.66
	ULENTL-5	UL-Listed Adjustable Dead Latch 2 3/8" or 2 3/4" with round corner faceplate for Entrance Leversets	17.66
	ULPASL-7	UL-Listed Adjustable Spring Latch 2 3/8" or 2 3/4" with round corner faceplate for Passage Leversets	17.66
	ULDB-8	UL-Listed Adjustable Deadbolt Latch 2 3/8" or 2 3/4" for Deadbolts	23.11

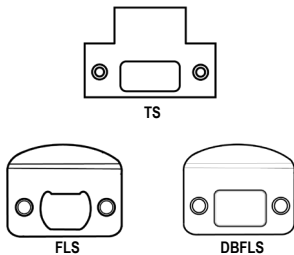
► **ADDITIONAL PARTS & CHARGES FOR CHELSIE, CONTEMPORARY, AND SUMMIT SERIES**

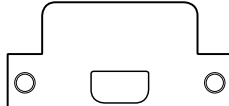
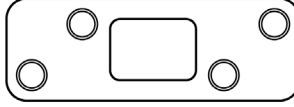
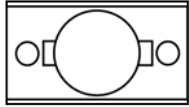
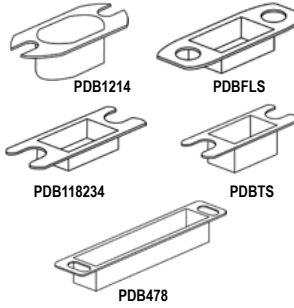
ILLUSTRATION	ITEM #	DESCRIPTION	LIST PRICE
	TS	T-Strike	5.33
	FLS	Full Lip Strike	
	DBFLS	Deadbolt Full Lip Strike, Round Corner	3.79
	ASAST US3, 26D, 26	ANSI ASA Strike	4.98
	ASAST US10B, 10	ANSI ASA Strike	7.47
	EXASA-175 US32D, DURO	Extended Lip ANSI Strike 1 3/4" Lip Extension from Screw Center Line	44.91
	SS114358	Security Strike 1 1/4" X 3 5/8", 1/4" Rad With 2 pcs. each of 3" and 1 1/4" Screws US3, 5, 25, 26D, 10B	6.64
	K1-KEY	Blank Keys K1	1.66
	KEYS	Extra Cut Keys	3.91
	LFA18	Latch Front Adapter To Convert 1" Faceplate To 1 1/8" Wide Door Preparation	0.71
	PDBFLS	Plastic Dust box for Full Lip Strike	3.32
	PDB1214	Plastic Dust box for Residential Deadbolt Strike 1" x 2 1/4"	
	PDB118234	Plastic Dust box for T-Strike 1 1/8" x 2 3/4"	
	PDBTS	Plastic Dust box for Deadbolt T2STRK Strike	
	PDB478	Plastic Dust box for ASA Strike	6.52
◆ KEYING KITS			
	KKWI200	Keying Kit - KWI Keyway	282.03
◆ MOUNT			
	RESMOUNT	3 Hole Mount For Residential Locks	173.01

KEYING CHARGES

ITEM #	DESCRIPTION	LIST PRICE
KARES	Key alike	5.81
MKRES	Master key (Including KA charges)	7.35
CMKRES	Builder construction master key (Including KA & MK Charges)	10.19
GMKRES	Grand master key (Including KA, MK)	13.15

VANGUARD Series List Price

RESIDENTIAL LEVERS AND DEADBOLTS, ANSI STANDARD A156.2, GRADE 3

► KEYWAYS (STD, "KW" 5-PIN KWIKSET) OPTIONAL 5-PIN SCHLAGE "C" & WEISER

- All locksets, and deadbolts are available with **Schlage "C"** and **Weiser** keyway on special factory order only, with no additional charge. Consult factory.
- **SCHLAGE "C" KEYWAY OPTION:** For immediate stock shipment add **\$8.21 List** for keyed entrance lock and single cylinder deadbolts. Prefix C before Part # (Ex: MOD-00 with C keyway is CMOD-00)
- **WEISER KEYWAY OPTION:** For keyed knob and leversets add **\$5.22 List**. For Single Cylinder Deadbolts, add **\$7.77 List** and for Double Cylinder Deadbolts add **\$15.43 List**. Prefix "W" before Part # (Ex: MOD-00 with Weiser keyway is WMOD-00)

► LEVERSET DESIGNS

► DEADBOLT DESIGNS

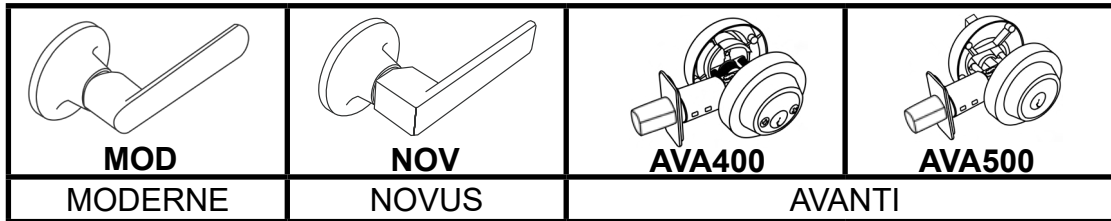

STOCK ITEM PRICES IN BOLD
NON-STOCK FINISHES AND DESIGNS AVAILABLE WITH FACTORY LEAD TIME AND SUBJECT TO MINIMUM ORDER

MODERNE ----- MOD SERIES

FUNCTIONS	ANSI	ITEM #	US11P	US15	US26	US26D	US3	US5	US15A	PCS / MC
Entry - KA / 3	F109	MOD-00	\$65.50	\$57.72	\$63.58	\$57.72	\$57.72	\$63.58	\$63.58	20
Storeroom - KA / 3	F86	MOD-05	65.50	57.72	63.58	57.72	57.72	63.58	63.58	
Privacy	F76	MOD-20	60.07	52.29	57.72	52.29	52.29	57.72	57.72	
Passage	F75	MOD-30	57.72	50.06	54.95	50.06	50.06	54.95	54.95	
Active Dummy	----	MOD-40	33.02	25.24	27.90	25.24	25.24	27.90	27.90	36

 Prefix "UL" before Part # when ordering UL Listed, available on Entrance and Passage functions. Add **\$7.35 List**.

NOVUS ----- NOV SERIES

FUNCTIONS	ANSI	ITEM #	US11P	US15	US26	US26D	US3	US5	US15A	PCS / MC
Entry - KA / 3	F109	NOV-00	\$65.50	\$57.72	\$63.58	\$57.72	\$57.72	\$63.58	\$63.58	20
Storeroom - KA / 3	F86	NOV-05	65.50	57.72	63.58	57.72	57.72	63.58	63.58	
Privacy	F76	NOV-20	60.07	52.29	57.72	52.29	52.29	57.72	57.72	
Passage	F75	NOV-30	57.72	50.06	54.95	50.06	50.06	54.95	54.95	
Active Dummy	----	NOV-40	33.02	25.24	27.90	25.24	25.24	27.90	27.90	36

 Prefix "UL" before Part # when ordering UL Listed, available on Entrance and Passage functions. Add **\$7.35 List**.

AVANTI ----- AVA SERIES

FUNCTIONS	ANSI	ITEM #	US11P	US15	US26	US26D	US3	US5	US15A	PCS / MC
Single Cylinder Deadbolt - KA / 3	E0153	AVA500	\$63.37	\$58.58	\$63.37	\$58.58	\$58.58	\$63.37	\$58.58	36
Double Cylinder Deadbolt - KA / 3	E0143	AVA400	81.15	75.62	80.41	75.62	75.62	80.41	80.41	

► LEVERSET PACKAGING INCLUDES

- Kwikset rekeyable 5 pin cylinder
- **6-way** 2 3/8" or 2 3/4" adjustable backset, size 1" x 2 1/4" round corner standard. Square corner option and drive-in latchbolt also available on special factory order.
- Round Corner Full Lip Strike: 1 3/4" x 2 1/4"
- Keyed entry comes with lever / lever for exterior and interior
- 1" bore diameter for latch, 2 1/8" diameter for lock housing

► DEADBOLT PACKAGING INCLUDES:

- Kwikset rekeyable 5 pin cylinder
- **6-way** 2 3/8" or 2-3/8" or 2 3/4" adjustable backset, size 1" x 2 1/4" round corner standard, convertible to drive in latch
- Full 1" throw deadbolt
- 1" x 2 1/4" round corner strike standard

ITALIA Series List Price

**STAINLESS STEEL LOCKSETS, KNOBSETS,
ESCUTCHEONS, ANSI STANDARD A156.2, GRADE 3
OPTIONAL GRADE 2**

HOW TO ORDER					
DDD-FFB-[H]R US32X					
DESIGN (ddd)	FUNCTION (FF)	BACKSET (b)	HANDING (H)	ROSE (R)	FINISH (US32X)
See Lever / Knob Designs in the table below	00 - Entrance 20 - Privacy 30 - Passage 40 - Single Dummy	8 - 2 3/8" (standard) 4 - 2 3/4" 2 - Gr. 2 (Passage) 2H - Gr 2 (L / R - Privacy) 2V - Gr. 2 (RHR/LHR -Privacy)	L - Left Hand R - Right Hand SPECIFY for Handed Levers or Scudo Privacy	G - Giro Q - Quadro S - Scudo	US32D - Satin SS US32 - Polished SS



LEVER DESIGNS	FUNCTION + 2 3/8" BACKSET STD		HANDING	ROSE DESIGN						PCS / MC		UPGRADE TO GRADE 2	
				G (ROUND)		Q (SQUARE)		S (ESCUTCHEON)		Q	S		
				US32D	US32	US32D	US32	US32D	US32	G	S		
LUCCA - LUC TURIN - TUR FERRARA - FER RAVENA - RAV *PISA - PIS	ENTRANCE w/ deadbolt	00	8	L / R *Handed			\$298.20	\$328.02			6	ADD \$33.18	
	PRIVACY	20	8		\$142.71	\$157.62	\$157.62	\$174.66	259.86"	285.42"			24
	PASSAGE	30	8		142.71	157.62	157.62	174.66	259.86	285.42			
	DUMMY (SINGLE)	40			76.68	85.20	85.20	93.72	129.93	142.71			36



LEVER DESIGNS	FUNCTION + 2 3/8" BACKSET STD		HANDING	ROSE DESIGN						PCS / MC		UPGRADE TO GRADE 2	
				G (ROUND)		Q (SQUARE)		S (ESCUTCHEON)		Q	S		
				US32D	US32	US32D	US32	US32D	US32	G	S		
PERUVIA - PER VENICE - VEN SALERNO - SAL POMPEI - POM SYRACUSE - SYR	ENTRANCE w/ deadbolt	00	8	Non-handed			\$298.20	\$328.02			6	ADD \$33.18	
	PRIVACY	20	8		164.01	181.05	181.05	200.22	259.86"	285.42"			24
	PASSAGE	30	8		164.01	181.05	181.05	200.22	259.86	285.42			
	DUMMY (SINGLE)	40			83.07	91.59	91.59	100.11	129.93	142.71			36

- HANDED - HOLLOW - SOLID

"Specify Handing when ordering Privacy function with Scudo rose design"

ROSE DESIGNS

ITALIA Series List Price

STAINLESS STEEL LOCKSETS, KNOBSETS, ESCUTCHEONS, ANSI STANDARD A156.2, GRADE 3 OPTIONAL GRADE 2

LEVER DESIGNS	FUNCTION + 2 3/8" BACKSET STD			HANDING	ROSE DESIGN						PCS / MC		UPGRADE TO GRADE 2
					G (ROUND)		Q (SQUARE)		S (ESCUTCHEON)		Q	S	
					US32D	US32	US32D	US32	US32D	US32	G	S	
SOLID LEVER DESIGNS *SIENA - SIE *LIVORNO - LIV *VICENZA - VIC BRESCIA - BRE	ENTRANCE w/ deadbolt	00	8	L / R *Handed					328.02	359.97			ADD \$33.18
	PRIVACY	20	8		185.31	204.48	204.48	223.65	285.42"	313.11"	24	6	
	PASSAGE	30	8		185.31	204.48	204.48	223.65	285.42	313.11			
	DUMMY (SINGLE)	40			89.46	100.11	100.11	110.76	142.71	156.55	36		
LEVER DESIGNS	FUNCTION + 2 3/8" BACKSET STD			HANDING	ROSE DESIGN						PCS / MC		UPGRADE TO GRADE 2
					G (ROUND)		Q (SQUARE)		S (ESCUTCHEON)		Q	S	
					US32D	US32	US32D	US32	US32D	US32	G	S	
KNOB DESIGNS PADERNO - PAD PALERMO - PAL PAVIA - PAV	ENTRANCE w/ deadbolt	00	8	Non-handed					359.97	396.20			ADD \$33.18
	PRIVACY	20	8		200.22	219.39	219.39	240.69	313.10"	345.06"	24	6	
	PASSAGE	30	8		200.22	219.39	219.39	240.69	313.10	345.06			
	DUMMY (SINGLE)	40			100.11	142.71	142.71	121.41	156.55	172.53	36		

► **STANDARD PACKAGING INCLUDES**

GIRO AND QUADRO ROSE STYLE LEVERSETS / KNOBSETS

- Non-handed 2 3/8" backset (2 1/4" x 1", 1/4" radius) standard
- Full lip strike round corner 1/4" radius, T-Strike, 1 1/8" x 2" square corner

SCUDO ESCUTCHEON STYLE

- Schlage "C" 5-pin cylinder on deadbolt (Entrance Function)
- Non-handed 2 3/8" backset (2 1/4" x 1", 1/4" radius) standard
- Full lip strike round corner 1/4" radius, T-Strike, 1 1/8" x 2" square corner

► **OPTIONS**

- Optional 2 3/4" backset and 4-way, Adjustable Grade 2 Drive-in latch bolt
- See PARTS and ACCESSORIES on page L94

****Specify Handing when ordering Privacy function with Scudo rose design**



- HANDED







- HOLLOW

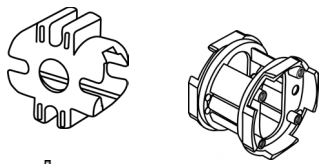
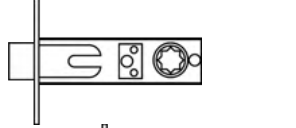
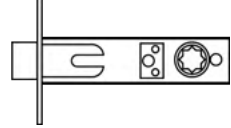
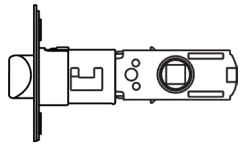
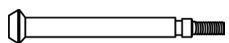

- SOLID

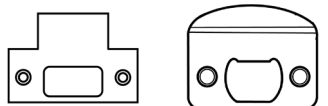
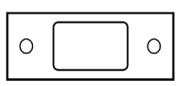
► **ADDITIONAL PARTS & CHARGES FOR ITALIA SERIES**

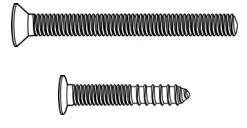
ILLUSTRATION	ITEM#	DESCRIPTION	UOM	LIST PRICE
	APS PVC	Anti-pry Shield PVC material	EACH	\$5.33
	APS ZINC	Anti-pry Shield Zinc material		5.33
	CTPAS238	Passage 2 3/8" backset (fixed)		33.18
	CTPRI238	Privacy 2 3/8" backset (fixed)		
	CTPAS234	Passage 2 3/4" backset (fixed)		
	CTRPRI234	Privacy 2 3/4" backset (fixed)		
	G2PAS	Grade 2 (4-way) Passage Adjustable 2 3/8" and 2 3/4" backset (non-handed)		
	G2PRILR	Grade 2 (4-way) Handed Privacy Adjustable 2 3/8" and 2 3/4" backset (L / R). Used for Escutcheon Privacy (SCU)		
	G2PRIIO	Grade 2 (4-way) Handed Privacy Adjustable 2 3/8" and 2 3/4" backset (LHR / RHR). Used for Escutcheon Privacy (SCU)		
	CTPRIPIN US32D	Privacy Pin Satin Stainless Steel Finish		3.20
	CTPRIPIN US32	Privacy Pin Polished Stainless Steel Finish		3.20
	ALLENKEY	Allen Key		1.50
	EMRELPIN	Emergency Release Pin		1.40
	TS	T-Strike		5.33
	FLS	Full Lip Strike		
	ITA-FP US32D	Latch Face Plate Italia Series		1.50
	ITA-FP US32	Latch Face Plate Italia Series		
	ITA-SB	Plastic Strike Box Italia Series		3.30
	ITA-SETSCREW	M4 x 0.7 Lever / Knob set screws Italia Series		0.75
	ITA-SCREWPACK	8-32 x 1 1/2" Screws for lock body Italia Series (PAIR)		PAIR
	ITA-COMBISCREW	8-32 x 1" Combination metal-wood screws Italia Series (PAIR)	0.75	

► For Keying charges see page L115.

ITALIA Series List Price

STAINLESS STEEL MORTISE LOCKS, ANSI STANDARD A156.2, GRADE 1

FUNCTIONS	ANSI	FINISH		PCS / MC
		US32D	US32	
◀Single cylinder without deadbolt				
NM8050 - Office / Entrance	F04	\$639.29	\$696.82	6
NM8070 - Classroom	F05			
NM8080 - Storeroom	F07			
◀Single cylinder with deadbolt				
NM8453 - Entrance	F20	651.99	717.06	6
NM8456 - Corridor	F13			
NM8495 - Keyed Privacy w/ Indicator	----	811.74	811.74	
NM8465 - Closet / Storeroom	----	651.99	716.42	
NM8473 - Dormitory / Bedroom	F21			
◀Double cylinder without deadbolt				
NM8060 - Apartment Entrance	F09	679.87	741.13	6
NM8082 - Institution	F30			
◀Double cylinder with deadbolt				
NM8466 - Storeroom	F14			
◀Other Functions				
NM8040 - Privacy with Deadbolt	F02,F19,F22	616.44	672.00	6
NM8445 - Privacy with Indicator	----	776.20	846.15	
NM8010 - Passage	F01	550.49	600.12	

⚙️ All keyed lock functions are available with **Best, Falcon and Arrow, Schlage, Corbin / Russwin, Sargent, and Yale Large Format Interchangeable Cores** (See page L15 for additional charges). Prices do not include cores. For IC Core pricing see pages L105 – L106. For Keying charges see page L115.

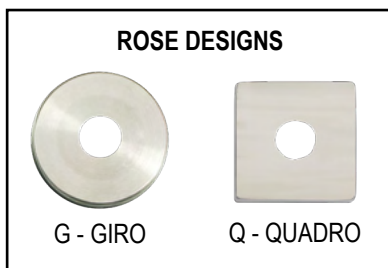

ORDERING FOR NM SERIES MORTISE LOCK

The Lever and Knob designs can also be used for our NM Series Mortise Locks. To order, refer to functions in the NM Series page and choose a function, indicate handing, lever / knob design, rose design (G or Q) and finish: **NMnnnnHH-ddd-r US32x**
e.g. :

To order NM8080 function LH in SIENA lever design with round rose in US32D finish use:

NM8080LH-SIE-G US32D

ITALIA Series List Price

STAINLESS STEEL DEADBOLTS WITH GRADE 1 LATCH

ANSI STANDARD A156.2, GRADE 3

- ▶ KEYWAY standard 5-PIN SCHLAGE "C"
 - Latch Bolt: Grade 1, 4-way Drive-In, Brass, Satin Nickel bolt
 - Latch Backset: Adjustable 2 3/8 (60) and 2 3/4 (70)
 - Handing: Non-Handed
 - Latch Faceplate: 1" x 2 1/4" (25 x 57)
 - Deadbolt Strike: 1 1/8" x 2 3/4" (29 x 70) square corner (standard)
 - Security Strike: 1 1/8" x 2 3/4" x 3/32" (29 x 70 x 2) (standard)
 - Keying service available

▶ **DEADBOLT DESIGNS**

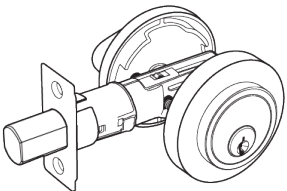
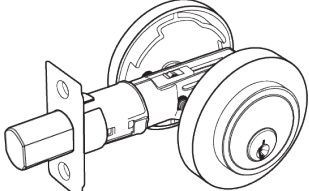
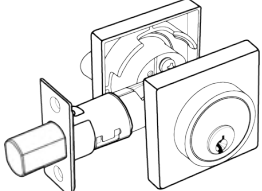
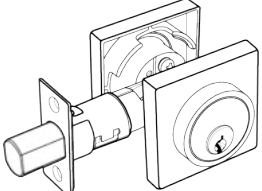
			
RND-504 / RND-508 SINGLE CYLINDER	RND-404 DOUBLE CYLINDER	SQR-504 / SQR-508 SINGLE CYLINDER	SQR-404 DOUBLE CYLINDER
ROUND		SQUARE	

DEADBOLT ----- ITALIA SERIES

FUNCTIONS	ANSI	ITEM #	US32D	US32	PCS / MC
Single Cylinder Round Deadbolt for 1 3/4" Door Thickness	E0153	RND-504	\$108.65	\$119.28	18
Single Cylinder Round Deadbolt for 1 3/8" Door Thickness	E0153	RND-508	108.65	119.28	
Single Cylinder Square Deadbolt for 1 3/4" Door Thickness	E0153	SQR-504	108.65	119.28	
Single Cylinder Square Deadbolt for 1 3/8" Door Thickness	E0153	SQR-508	108.65	119.28	
Double Cylinder Round Deadbolt for 1 3/4" Door Thickness	E0143	RND-404	123.54	136.32	
Double Cylinder Square Deadbolt for 1 3/4" Door Thickness	E0143	SQR-404	123.54	136.32	

▶ For Keying charges see page L115.

HERITAGE Series List Price

RESIDENTIAL LEVERS AND DEADBOLTS

ANSI STANDARD A156.2, GRADE 3

► **KEYWAYS (STD, "KW" 5-PIN KWIKSET) OPTIONAL 5-PIN SCHLAGE "C" & WEISER**

- All locksets and deadbolts are available with **Schlage "C"** and **Weiser** keyway on special factory order only, with no additional charge. Consult factory
- **SCHLAGE "C" KEYWAY OPTION:** For immediate stock shipment, add **\$9.35List** for keyed entrance lock and single cylinder deadbolts Prefix "C" before Part # (Ex: AZU-00 with C keyway is CAZU-00)
- **WEISER KEYWAY OPTION:** For keyed leversets, add **\$5.55 List**. For Single Cylinder Deadbolts, add **\$9.35List** and for Double Cylinder Deadbolts add **\$15.80List**. Prefix "W" before Part # (Ex: AZU-00 with Weiser keyway is WAZU-00)

► **LEVERSET DESIGNS**

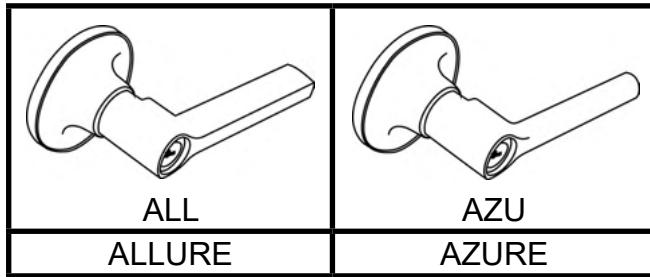

**STOCK ITEM PRICES
IN BOLD**

**NON-STOCK FINISHES AND
DESIGNS AVAILABLE WITH
FACTORY LEAD TIME AND
SUBJECT TO MINIMUM ORDER**

AZURE ----- AZU SERIES

FUNCTIONS	ANSI	ITEM #	US3	US5	US11P	US15	US15A	US26	US26D	PCS / MC
Entry - KA / 3	F109	AZU-00	\$53.88	\$59.21	\$61.02	\$53.88	\$59.21	\$59.21	\$53.88	24
Storeroom - KA / 3	F86	AZU-05	53.88	59.21	61.02	53.88	59.21	59.21	53.88	
Privacy	F76	AZU-20	48.77	53.88	56.01	48.77	53.88	53.88	48.77	
Passage	F75	AZU-30	46.64	51.33	53.88	51.33	51.33	51.33	46.64	
Active Dummy	----	AZU-40	23.53	25.98	30.77	23.53	25.98	25.98	23.53	36

Prefix "UL" before Part # when ordering UL Listed, available on Entrance and Passage functions. Add \$7.45 List.

ALLURE ----- ALL SERIES

FUNCTIONS	ANSI	ITEM #	US3	US5	US11P	US15	US15A	US26	US26D	PCS / MC
Entry - KA / 3	F109	ALL-00	53.88	59.21	61.02	53.88	59.21	59.21	53.88	24
Storeroom - KA / 3	F86	ALL-05	53.88	59.21	61.02	53.88	59.21	59.21	53.88	
Privacy	F76	ALL-20	48.77	53.88	56.01	48.77	53.88	53.88	48.77	
Passage	F75	ALL-30	46.64	51.33	53.88	51.33	51.33	51.33	46.64	
Active Dummy	----	ALL-40	23.53	25.88	30.77	23.53	25.98	25.98	23.53	36

Prefix "UL" before Part # when ordering UL Listed, available on Entrance and Passage functions. Add \$7.45 List.

► **LEVERSET PACKAGING INCLUDES**

- Kwikset rekeyable 5-pin cylinder
- 2 3/8" or 2 1/4" adjustable backset, size 1" x 2 1/4" round corner standard
Square corner option and drive-in latchbolt also available on special factory order
- Round Corner Full Lip Strike: 1 3/4" x 2 1/4"
- Keyed entry comes with lever / lever for exterior and interior
- 1" bore diameter for latch, 2 1/8" diameter for lock housing

**5 Year Finish Warranty
25 Year Mechanical Warranty**

LEGACY Series List Price

RESIDENTIAL LEVERS A156.2, GRADE 3

► KEYWAYS (STD, "KW" 5-PIN KWIKSET) OPTIONAL 5-PIN SCHLAGE "C" & WEISER

- All locksets and deadbolts are available with **Schlage "C"** and **Weiser** keyway on special factory order with no additional charge, or from stock with additional charges. See below.
- **SCHLAGE "C" KEYWAY OPTION:** For immediate stock shipment **add \$9.35 List** for keyed locks and single cylinder deadbolts. Prefix "C" before Part # (Ex: ZUL00 with C keyway is CZUL00)
- **WEISER KEYWAY OPTION:** For immediate stock shipment **add \$9.35List** for keyed locks and single cylinder deadbolts. Prefix "W" before Part # (Ex: ZUL00 with Weiser keyway is WZUL00)
- Prefix "UL" before Part # when ordering UL Listed, available on Entrance, Storeroom, Privacy, Passage and Deadbolt functions. **Add \$11.00 to List** for Leversets and **\$12.35 to List** for Deadbolts.



STOCK ITEM PRICES IN BOLD

NON-STOCK FINISHES AND DESIGNS AVAILABLE WITH FACTORY LEAD TIME AND SUBJECT TO MINIMUM ORDER

CABERNET ----- CAB DESIGN

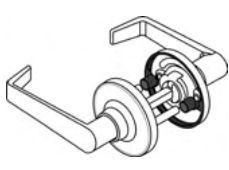
	FUNCTIONS	ANSI	ITEM #	US15	US26D	US11P	US5	15A / 26	US3	PCS / MC
	Entrance w/ Push Button	F109	CAB00	\$76.68	\$76.68	\$85.09	\$76.68	\$85.09	\$72.85	24
	Storeroom	F86	CAB05	76.68	76.68	85.09	76.68	85.09	72.85	24
	Privacy w/ Push Button	F76	CAB20	60.71	60.71	85.09	55.91	62.09	53.14	24
	Passage	F75	CAB30	53.78	53.78	38.70	46.33	51.44	43.99	24
	Dummy	--	CAB40	25.03	25.03	36.53	24.60	27.26	23.32	24

ZULU ----- ZUL DESIGN

	FUNCTIONS	ANSI	ITEM #	US15	US26D	US11P	US5	15A / 26	US3	PCS / MC
	Entrance w/ Push Button	F109	ZUL00	\$76.68	\$76.68	\$85.09	\$76.68	\$85.09	\$72.85	24
	Storeroom	F86	ZUL05	76.68	76.68	85.09	76.68	85.09	72.85	24
	Privacy w/ Push Button	F76	ZUL20	60.71	60.71	85.09	55.91	62.09	53.14	24
	Passage	F75	ZUL30	53.78	53.78	38.70	46.33	51.44	43.99	24
	Dummy	--	ZUL40	25.03	25.03	36.53	24.60	27.26	23.32	24

DUCATI ----- DUC DESIGN

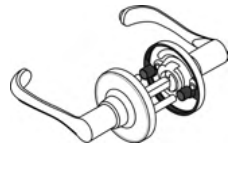
	FUNCTIONS	ANSI	ITEM #	US15	US26D	US11P	US5	15A / 26	US3	PCS / MC
	Entrance w/ Push Button	F109	DUC00	\$80.62	\$80.62	\$89.57	\$80.62	\$89.57	\$74.23	24
	Storeroom	F86	DUC05	80.62	80.62	89.57	80.62	89.57	74.23	24
	Privacy w/ Push Button	F76	DUC20	65.50	65.50	74.98	64.01	71.14	58.90	24
	Passage	F75	DUC30	58.68	58.68	68.37	53.36	59.21	49.10	24
	Dummy	--	DUC40	27.05	27.05	30.03	25.56	28.44	23.54	24

NAPA ----- NAP DESIGN

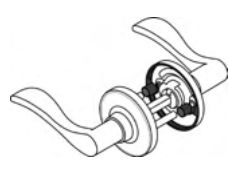
	FUNCTIONS	ANSI	ITEM #	US15	US26D	US11P	US5	15A/26	US3	PCS / MC
	Entrance w/ Push Button *SH	F109	NAP00	\$87.86	\$87.86	\$97.55	\$87.86	\$97.55	\$80.83	24
	Storeroom *SH	F86	NAP05	87.86	87.86	97.55	87.86	97.55	80.83	24
	Privacy w/ Push Button *SH	F76	NAP20	70.18	70.18	79.77	69.55	77.32	64.01	24
	Passage *SH	F75	NAP30	63.58	63.58	73.06	59.43	66.03	54.64	24
	Dummy *SH	--	NAP40	29.29	29.29	33.23	27.48	30.46	25.24	24

*SH is for Specify Handing

DENMARK ----- DEN DESIGN

	FUNCTIONS	ANSI	ITEM #	US15	US26D	US11P	US5	15A / 26	US3	PCS / MC
	Entrance w/ Push Button	F109	DEN00	\$87.86	\$87.86	\$97.55	\$87.86	\$98.41	\$80.83	24
	Storeroom	F86	DEN05	87.86	87.86	97.55	87.86	98.41	80.83	24
	Privacy w/ Push Button	F76	DEN20	70.18	70.18	79.77	69.55	77.32	64.01	24
	Passage	F75	DEN30	63.58	63.58	73.06	59.43	59.43	54.64	24
	Dummy	--	DEN40	29.29	29.29	32.27	27.48	27.48	25.24	24

VIARGENTO ----- VIA DESIGN

	FUNCTIONS	ANSI	ITEM #	US15	US26D	US11P	US5	15A / 26	US3	PCS / MC
	Entrance w/ Push Button *SH	F109	VIA00	\$87.86	\$87.86	\$97.55	\$87.86	\$97.55	\$80.83	24
	Storeroom *SH	F86	VIA05	87.86	87.86	97.55	87.86	97.55	80.83	24
	Privacy w/ Push Button *SH	F76	VIA20	70.18	70.18	79.77	69.55	77.32	64.01	24
	Passage *SH	F75	VIA30	63.58	63.58	73.06	59.43	66.03	54.64	24
	Dummy *SH	--	VIA40	29.29	29.29	33.23	27.48	30.46	25.24	24

*SH is for Specify Handing

► **LEVERSET PACKAGING INCLUDES**

- 2 3/8" or 2 3/4" 4-way adjustable backset, size 1" x 2 1/4" round corner standard, convertible to drive-in latch. Square corner face plate and 5" round corner backsets optional.
- All locksets are packed with full lip strike round corner 1/4" radius
- Screw Guiding Posts for easy screw alignment and tightening making installation fast and easy.
- Push button release on entrance and privacy from inside by turning lever.
- Kwikset rekeyable 5 pin cylinder

CLIPPER Series List Price

RESIDENTIAL DEADBOLTS A156.2, GRADE



STOCK ITEM PRICES IN BOLD
NON-STOCK FINISHES AND DESIGNS AVAILABLE WITH FACTORY LEAD TIME AND SUBJECT TO MINIMUM ORDER

	FUNCTIONS	ITEM #	US15	US26D	US11P	US3	US5	PCS / MC
	Single Cylinder Deadbolt	CLP500	\$42.49	\$42.49	\$47.29	\$39.19	\$42.49	24
	Double Cylinder Deadbolt	CLP400	51.65	51.65	57.40	47.61	51.65	24
	One Sided Deadbolt with Cover	CLP801	35.57	35.57	39.51	32.70	35.57	24
	One Sided Deadbolt	CLP701	22.90	22.90	25.45	21.09	22.90	24

Optional **UL Listed Latch**. Add **\$12.32** to

► **DEADBOLT PACKAGING INCLUDES:**

- 2 3/8" or 2 3/4" 4-way adjustable backset, size 1" x 2 1/4" round corner standard, convertible to drive-in latch. Square corner face plate and 5" round corner backsets optional.
- Deadbolts packed with 1" x 2 1/4" strike round corner 1/4" radius and full lip strike 1/4" radius. Square corner available upon request.
- Security strike (1 1/4" x 3 3/8" x 1/4" radius) with 3" screws available with an additional charge.
- Kwikset rekeyable 5 pin cylinder

► **ADDITIONAL PARTS AND CHARGES FOR VANGUARD, HERITAGE, LEGACY, AND CLIPPERS SERIES**

ILLUSTRATION	ITEM#	DESCRIPTION	LIST PRICE
	LGEN-5 US32D	5" Entrance Deadlatch Round Corner for Legacy Series	\$16.47
	LGEN-5 US11P	5" Entrance Deadlatch Round Corner for Legacy Series	16.47
	LGPA-5 US32D	5" Privacy / Passage Spring Latch Round Corner for Legacy Series	16.47
	LGPA-5 US11P	5" Privacy / Passage Spring Latch Round Corner for Legacy Series	16.47
	LGST-5 US32D	5" Storeroom Dead Latch Round Corner for Legacy Series	16.47
	LGST-5 US11P	5" Storeroom Dead Latch Round Corner for Legacy Series	16.47
	LGDB-5 US32D	5" Deadbolt Latch Round Corner for Legacy Series	16.47
	LGDB-5 US11P	5" Deadbolt Latch Round Corner for Legacy Series	16.47
	LGEN-1 US32D	Adjustable Entrance 4-Way Dead Latch 2 3/8" or 2 3/4" Round Corner w/ Drive-in Collar for Legacy Series	9.48
	LGEN-1 US11P	Adjustable Entrance 4-Way Dead Latch 2 3/8" or 2 3/4" Round Corner w/ Drive-in Collar for Legacy Series	9.48
	LGPA-3 US32D	Adjustable Privacy / Passage 4-Way Spring Latch 2 3/8" or 2 3/4" Round Corner w/ Drive-in Collar for Legacy Series	9.48
	LGPA-3 US11P	Adjustable Privacy / Passage 4-Way Spring Latch 2 3/8" or 2 3/4" Round Corner w/ Drive-in Collar for Legacy Series	9.48
	LGDB-2 US32D	Adjustable 4-Way Deadbolt Latch 2 3/8" or 2 3/4" Round Corner w/ Drive-in Collar for Legacy Series	11.02
	LGDB-2 US11P	Adjustable 4-Way Deadbolt Latch 2 3/8" or 2 3/4" Round Corner w/ Drive-in Collar for Legacy Series	11.02
	LGSCEN-9 US32D	Square Corner Faceplate for Storeroom / Entrance Legacy Series	1.19
	LGSCEN-9 US11P	Square Corner Faceplate for Storeroom / Entrance Legacy Series	1.19
	LGSCPP-8 US32D	Square Corner Faceplate for Privacy / Passage Legacy Series	1.19
	LGSCPP-8 US11P	Square Corner Faceplate for Privacy / Passage Legacy Series	1.19
	LGSCDB-7 US32D	Square Corner Faceplate for Deadbolt Legacy Series	1.19
	LGSCDB-7 US11P	Square Corner Faceplate for Deadbolt Legacy Series	1.19
	ULLGEN-1	UL-Listed Adjustable Dead Latch 2 3/8" or 2 3/4" with round corner faceplate for Entrance and Storeroom Leversets	14.81
	ULLGPAS-3	UL-Listed Adjustable Spring Latch 2 3/8" or 2 3/4" with round corner faceplate for Privacy and Passage Leversets	14.81
	ULLGDB-2	UL-Listed Adjustable Deadbolt Latch 2 3/8" or 2 3/4" for Deadbolts	16.12

▶ ADDITIONAL PARTS AND CHARGES FOR VANGUARD, HERITAGE, LEGACY, AND CLIPPERS SERIES

ILLUSTRATION	ITEM#	DESCRIPTION	LIST PRICE
	TS	T-Strike	\$5.33
	FLS	Full Lip Strike	
	DBFLS	Deadbolt Full Lip Strike, Round Corner	3.79
	ASAST US3, 26D, 26	ANSI ASA Strike	4.98
	ASAST US3, 26D, 26	ANSI ASA Strike	7.47
	EXASA-175 US32D, DURO	Extended Lip ANSI Strike 1 3/4" Lip Extension from Screw Center Line	44.91
	SS114358	Security Strike 1 1/4" x 3 5/8", 1/4" Rad With 2pcs each of 3" and 1 1/4" Screws US3, 5, 25, 26D, 10B	6.64
	K1-KEY	Blank Keys K1	1.66
	KEYS	Extra Cut Keys	3.91
	LFA18	Latch Front Adapter To Convert 1" Faceplate To 1 1/8" Wide Door Preparation	0.71
	PDBFLS	Plastic Dust box for Full Lip Strike	3.32
	PDB1214	Plastic Dust box for Residential Deadbolt Strike 1" x 2 1/4"	
	PDB118234	Plastic Dust box for T-Strike 1 1/8" x 2 3/4"	
	PDBTS	Plastic Dust box for Deadbolt T2STRK Strike	
	PDB478	Plastic Dust box for ASA Strike	6.52
◆ KEYING KITS			
	KKWI200	Keying Kit - KWI Keyway	282.03
◆ MOUNT			
	RESMOUNT	3 Hole Mount For Residential Locks	173.01

KEYING CHARGES

ITEM #	DESCRIPTION	LIST PRICE
KARES	Key alike	\$5.81
MKRES	Master key (Including KA charges)	7.35
CMKRES	Builder construction master key (Including KA & MK Charges)	10.19
GМКRES	Grand master key (Including KA, MK)	13.15

REPLACEMENT CYLINDERS . . .

- Made to Original Manufacturers' Keying Specifications
- All Cylinders drilled for 6-pins
- Can be keyed with original pins
- Packed with appropriate accessories

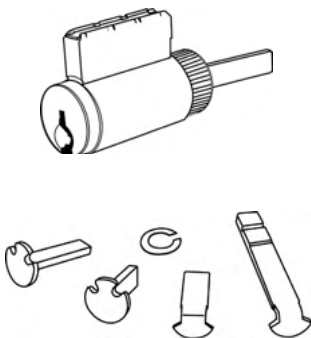
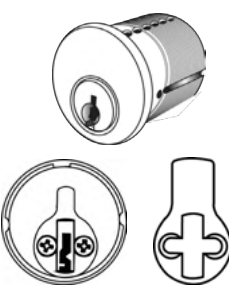
ILLUSTRATION	ITEM#	DESCRIPTION	KEYED	LIST PRICE EA	FINISH
KEY-IN-KNOB/LEVER & DEADBOLT CYLINDER (Packed with tailpiece assortment pack)					
 <div style="border: 1px solid black; padding: 5px; width: fit-content; margin-top: 10px;"> TAILPIECE ASSORTMENT PACK INCLUDED </div>	KKARA-4	6-pin Arrow "A"	5-pin	\$33.54	US26D
	KKC59-4	6-pin Corbin 60 Russwin 59	5-pin		
	KKCL4-4	6-pin Corbin L1 thru L4	6-pin		
	KKKW5-4	6-pin Kwikset	5-pin		
	KKRD1-4	6-pin Russwin D-1 thru 4	6-pin		
	KKSCC-4	6-pin Schlage "C"	6-pin		
	KKSCE-4	6-pin Schlage "E"	6-pin		
	KKSCF-4	6-pin Schlage "F"	6-pin		
	KKSCP-4	6-pin Schlage C-K	5-pin		
	KKSLA-4	6-pin Sargent "LA" thru "LC"	6-pin		
	KKSRA-4	6-pin Sargent "RA"	6-pin		
	KKWFE-4	6-pin Weiser / Falcon "E"	5-pin		
	KKYA8-4	6-pin Yale 8 (E1R)	5-pin		
	KKYGA-4	6-pin Yale "GA"	6-pin		
1-1/4" MORTISE CYLINDERS (Packed with Adams Rite and Yale Cams)					
 <div style="border: 1px solid black; padding: 5px; width: fit-content; margin-top: 10px;"> ADAMS RITE AND YALE CAMS INCLUDED </div>	KMARA-4	6-pin Arrow "A"	5-pin	46.45	US26D
	KMC59-4	6-pin Corbin 60 Russwin 59	5-pin		
	KMCL4-4	6-pin Corbin L1 thru L4	6-pin		
	KMKW5-4	6-pin Kwikset	5-pin		
	KMRD1-4	6-pin Russwin D-1 thru 4	6-pin		
	KMSCC-4	6-pin Schlage "C"	6-pin		
	KMSCE-4	6-pin Schlage "E"	6-pin		
	KMSCF-4	6-pin Schlage "F"	6-pin		
	KMSCP-4	6-pin Schlage C-K	5-pin		
	KMSLA-4	6-pin Sargent "LA" thru "LC"	6-pin		
	KMSRA-4	6-pin Sargent "RA"	6-pin		
	KMWFE-4	6-pin Weiser / Falcon "E"	5-pin		
	KMYA8-4	6-pin Yale 8 (E1R)	5-pin		
	KMYGA-4	6-pin Yale "GA"	6-pin		

► For KEYING charges see page L115

REPLACEMENT CYLINDERS . . .

- Made to Original Manufacturers' Keying Specifications
- All Cylinders drilled for 6-pins
- Can be keyed with original pins
- Packed with appropriate accessories

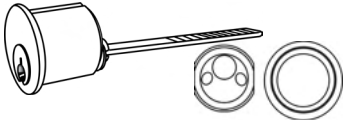
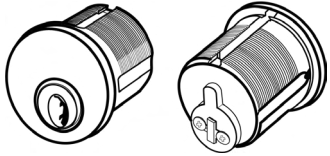
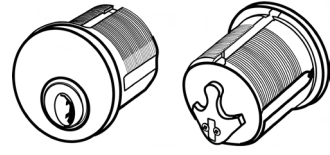

ILLUSTRATION	ITEM#	DESCRIPTION	KEYED	LIST EA	FINISH
MORTISE CYLINDER CAMS					
	KC-S1	Mortise Cylinder Adams Rite Cam		\$1.90	---
	KC-S3	Mortise Cylinder Yale Mortise Lock Cam		1.90	
	KC-S4	Mortise Cylinder Russwin Mortise Lock Cam		1.90	
	KC-S5	Mortise Cylinder Falcon Mortise Lock Cam		1.90	
	KC-S6	Mortise Cylinder Cal-Royal Panic Trim Cam		2.49	
	KC-S7	Mortise Cylinder CRP Mortise Lock -- (NM Series)		2.49	
	KC-S9	Mortise Cylinder NESC Panic Trim		2.49	

MORTISE CYLINDER ACCESSORIES					
	THBMORT100	1" Mortise Cylinder with Thumbturn		33.30	US26D
				34.60	US10B,3
	BLNMORT100	1" Blank Mortise Cylinder		33.30	US26D
				34.60	US10B,3
	MCCR1814	Mortise Cylinder Compression Ring 1/8" to 1/4"		21.21	US3, US10B, US26D
	MCCR3812	Mortise Cylinder Compression Ring 3/8" to 1/2"			
		CGR175	Cylinder Guard Ring 1 3/4" base and 1/2" projection with Wave Washer and Spacing Collar		13.51
	MCRC250	Free Spinning Cylinder Guard Ring 1/4"		6.99	US3, 15, 26D, 10B

ILLUSTRATION	ITEM#	DESCRIPTION	KEYED	LIST EA	FINISH
RIM CYLINDERS					
<p style="border: 1px solid black; padding: 2px; width: fit-content;">MOUNTING PLATE AND SCREWS INCLUDED</p>	KR-AR-A	Arrow "A"	5-pin	46.45	US26D
	KR-C-59	Corbin 60 Russwin 59	5-pin		
	KR-C-L4	Corbin L1 thru L4	6-pin		
	KR-KW-5	Kwikset	5-pin		
	KR-R-D1	Russwin D-1 thru 4	6-pin		
	KR-SC-C	Schlage "C"	6-pin		
	KR-SC-E	Schlage "E"	6-pin		
	KR-SC-F	Schlage "F"	6-pin		
	KR-SC-P	Schlage C-K	5-pin		
	KR-S-LA	Sargent "LA" thru "LC"	6-pin		
	KR-S-RA	Sargent "RA"	6-pin		
	KR-WF-E	Weiser / Falcon "E"	5-pin		
	KR-YA-8	Yale 8 (E1R)	5-pin		
	KR-Y-GA	Yale "GA"	6-pin		

► For KEYING charges see page L115

RIM AND MORTISE CYLINDERS

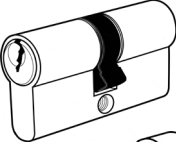
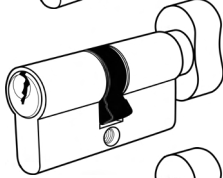
6-pin SCHLAGE "C" KEYWAY MORTISE AND RIM CYLINDERS				
ILLUSTRATION	ITEM #	DESCRIPTION	FINISH	LIST PRICE (EACH)
	CX96RIMKD	6-pin Schlage "C" keyway 1 1/8" Rim Cylinder with mounting plate & screws	US26D	\$33.30
			US10B,3	34.60
	AMORTCYL118	6-pin Schlage "C" Keyway Mortise Cylinder 1 1/8" length, with ADAMS RITE cam	US26D	33.30
			US10B,3	34.60
	AMORTCYL114	6-pin Schlage "C" Keyway Mortise Cylinder 1 1/4" length, with ADAMS RITE cam	US26D	33.30
			US10B,3	34.60
	CMORTCYL118	6-pin Schlage "C" Keyway Mortise Cylinder 1 1/8" length, with CLOVER LEAF cam	US26D	33.30
			US10B,3	34.60
	CMORTCYL114	6-pin Schlage "C" Keyway Mortise Cylinder 1 1/4" length, with CLOVER LEAF cam	US26D	33.30
			US10B,3	34.60
6-pin SCHLAGE "C" KEYWAY EUROPEAN PROFILE MORTISE CYLINDERS				
	SINGLE CYLINDER	KE-SCC-S-A	Single Cylinder 45mm Schlage "C", 6-pin rekeyable	42.31
		KE-SCC-D-C	Double Cylinder 60mm Schlage "C", 6-pin rekeyable	45.27
	DOUBLE CYLINDER	KE-SCC-D-D	Double Cylinder 70mm Schlage "C", 6-pin rekeyable	51.31
		KE-SCC-C-C	Single Cylinder with turn 60mm Schlage "C", 6-pin rekeyable	US15
SINGLE CYLINDER WITH TURN	KE-SCC-C-D			Single Cylinder with turn 70mm Schlage "C", 6-pin rekeyable
		BATHROOM CYLINDER	KE-P-C	Bathroom Cylinder 60mm
KE-P-D			Bathroom Cylinder 70mm	43.85
EASY REMOVABLE SCREW FOR RE-KEYING				

► For KEYING charges see page L115

BEST / FALCON 6 & 7-PIN SMALL FORMAT INTERCHANGEABLE CORES (SFIC) HOUSING & KEY BLANKS

KEY SECTIONS (A, B, C, D, E, F, G, H, J, K, L, M, Q, TB)



*All above keyways in stock for immediate shipment

MEETS
The Buy American Act

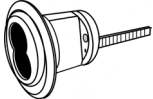

Features:

- Operates on Best / Falcon Small Format Interchangeable Cores locksets, deadbolts, rim and Mortise cylinders
- Operates on all of Cal-Royal's keyed locksets prepared for small format Best / Falcon A, B, C, D, E, F, G, H, J, K, L, M, Q, TB keyways

KEY SECTIONS	UNCOMBINATIONED	LIST EA.	MASTER KEYED	LIST EA.	KEY BLANKS	LIST EA.
A B	*6PUC A (6-pins)	US4, US26D \$38.39	6PCCA-MK (6-pins)	US4, US26D \$69.80	KBSF-A	NICKEL PLATED \$2.02
	*7PUC A (7-pins)		7PCC A-MK (7-pins)		KBSF-B	
	7PUC B (7-pins)		7PCC B-MK (7-pins)		KBSF-C	
C D	7PUC C (7-pins)		7PCC C-MK (7-pins)		KBSF-D	
	7PUC D (7-pins)		7PCC D-MK (7-pins)		KBSF-E	
E F	7PUC E (7-pins)		7PCC E-MK (7-pins)		KBSF-F	
	7PUC F (7-pins)		7PCC F-MK (7-pins)		KBSF-G	
G H	7PUC G (7-pins)		7PCC G-MK (7-pins)		KBSF-H	
	7PUC H (7-pins)		7PCC H-MK (7-pins)		KBSF-J	
J K L	7PUC J (7-pins)		7PCC J-MK (7-pins)		KBSF-K	
	7PUC K (7-pins)		7PCC K-MK (7-pins)		KBSF-L	
	7PUC L (7-pins)		7PCC L-MK (7-pins)		KBSF-M	
M Q TB	7PUC M (7-pins)		7PCC M-MK (7-pins)		KBSF-Q	
	7PUC Q (7-pins)		7PCC Q-MK (7-pins)		KBSF-TB	
	7PUC TB (7-pins)		7PCC TB-MK (7-pins)			
ILLUSTRATION	ITEM #	DESCRIPTION		FINISH	LIST EA.	
	308-602	Best / Falcon and Arrow 6 / 7-pin Small Format Interchangeable Core Rim Cylinder with mounting plate & screws		US26D	57.59	
				US10B,3	60.20	
	307-601	Best / Falcon and Arrow 6 / 7-pin Small Format Interchangeable Core Mortise Cylinder, with ADAMS RITE cam, 1 1/4"		US26D	57.59	
				US10B,3	60.20	
	ICH961387	Best / Falcon and Arrow 6 / 7-pin Small Format Interchangeable Core Mortise Cylinder, CLOVER LEAF cam 1 1/4" length. To be used with Cal-Royal NM Series mortise locks		US26D	76.79	
				US10B,3	79.51	
ITEM #	CONSTRUCTION CORES					
ICCC	Temporary 6-pin construction cores are available. Construction cores will be charged on a separate memo billing for 6 months. \$69.80 List Each. On return to the factory credit will be issued.					
ICCC7	Temporary 7-pin construction cores are available. Construction cores will be charged on a separate memo billing for 6 months. \$69.80 List Each. On return to the factory credit will be issued.					
ICPTT	Plastic thumb turns available for non-secured areas. \$14.58 List Each.					

► Standard Master Key Cylinders see above pricing. For other Keying charges see page L115.

LARGE FORMAT 6-Pin INTERCHANGEABLE CORE (LFIC) & HOUSING

Features:

- Operates on all **Schlage, Sargent, Russwin, Yale Large Format Interchangeable Cores** locksets, deadbolts, rim and Mortise cylinders.
- Operates on Cal-Royal's Commander Grade 2 leversets with large format, Genesys Grade 1 leversets with Large Format IC Core, T220 Series deadbolts with Large Format IC Core.

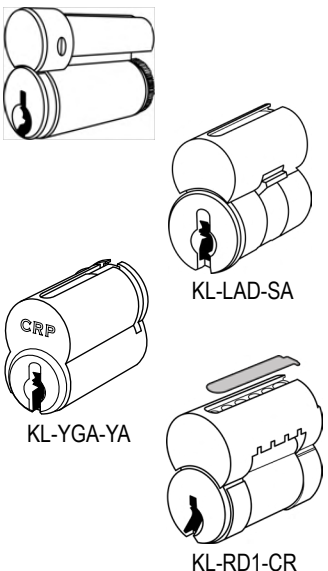
ILLUSTRATION	ITEM #	DESCRIPTION	FINISH	LIST PRICE (EA.)
 <p>KL-LAD-SA</p> <p>KL-YGA-YA</p> <p>KL-RD1-CR</p>	3000 ICC	6-pin "C" keyway combined Schlage large format IC core cylinder KA# 111111 with "C" keys	US3, US26D	\$95.87
	4000ICCK	6-pin "C-K" keyway combined Schlage large format IC core cylinder KA# 111111 with "E" keys		95.87
	5000ICE	6-pin "E" keyway combined Schlage large format IC core cylinder KA# 111111 with "E" keys		95.87
	1000ICC	6-pin "C" keyway combined Schlage large format IC core cylinder KD and MK		125.97
	2000 ICC	Temporary 6-pin Schlage large format IC Core Construction Cores (Keyed Alike) will be charged on a separate memo billing for 6 months. On return to the factory credit will be issued.		95.87
	KL-LAD-SA	Sargent LA-LB-LC LFIC 6-pin Uncombined	US26D	106.06
	KL-RD1-CR	Corbin / Russwin D1-D4 LFIC 6-pin Uncombined	US26D	106.06
	KL-YGA-YA	YALE GA LFIC 6-pin Uncombined	US26D	106.06

LARGE FORMAT 6-pin INTERCHANGEABLE CORE MORTISE AND RIM CYLINDERS



 <p>6000ICMA</p> <p>7000ICMC</p> <p>8000 ICRIM</p> <p>8000ICRIM</p> <p>RIM PACK</p>	6000ICMA	Schlage Large Format Interchangeable Core Mortise Cylinder with Adams Rite Cam 1 1/2" long	US3, US10B, US26D	78.45
	7000ICMC	Schlage Large Format Interchangeable Core Mortise Cylinder with Cloverleaf Cam 1 1/2" long. To be used with Cal-Royal NM Series Mortise locks		
	8000 ICRIM	Schlage Large Format Interchangeable Core rim Cylinder with mounting plate and screws		
	KM-LFH-SA	Sargent Large Format Interchangeable Core Mortise cylinder with Adams Rite Cam 1 1/2" long OPTIONAL RIM PACK	US26D	78.45
	KM-LFH-CR	Corbin / Russwin Large Format Interchangeable Core Mortise cylinder with Adams Rite Cam 1 1/2" long OPTIONAL RIM PACK		78.45
	KM-LFH-YA	YALE Large Format Interchangeable Core Mortise cylinder with Adams Rite Cam 1 1/2" long OPTIONAL RIM PACK		78.45
	RIM PACK	Mortise-Rim Combo component parts pack		5.81

Other CAMS available. See HSK Accessories Page L109-L111

► For **KEYING** charges see page L115

RESTRICTED KEY CONTROL REPLACEMENT CYLINDERS LIST Price

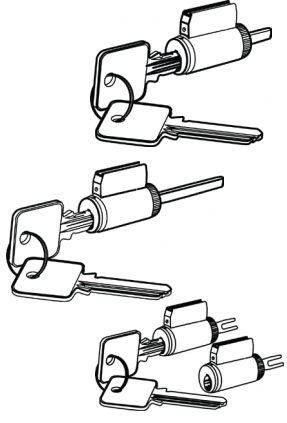
- Provide restricted key control by utilizing the HSK patented key control system
- Can be MASTER KEYED and / or KEYED ALIKE in combination with HSK HIGH SECURITY CYLINDERS
- Refer to HSK Pricelist for keying changes

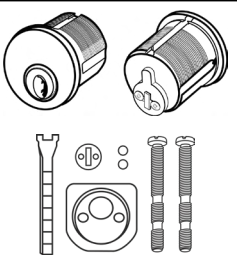
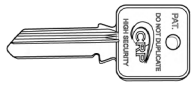
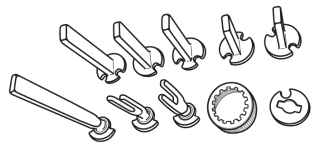
ILLUSTRATION	ITEM#	DESCRIPTION	LIST PRICE	FINISH	
6-pin, 0-BITTED KEY-IN-KNOB / LEVER & DEADBOLT REPLACEMENT CYLINDERS					
	KKCRL-6	Key-In-Knob / Lever Replacement Cylinder 6-pin "0 Bitted" Includes 2 Standard keys / Lever Tailpiece (other tailpieces available)	\$55.46	US26D	
	KKCRLSD-6	Single Cylinder Deadbolt Replacement Cylinder 6-pin "0 Bitted" Includes 2 keys	55.46		
	KKCRLDD-6	Double Cylinder Deadbolt Replacement Cylinder (2 required) 6-pin "0 Bitted" Includes 2 keys	110.92/ SET OF 2		
7-pin, UNCOMBINED REPLACEMENT CYLINDER / SMALL FORMAT IC CYLINDERS					
	7PUCCRS	Uncombined Small Format Interchangeable Core Conventional SFIC, 7-pin Does not include keys	71.57		
6-pin, 0-BITTED MORTISE / RIM CYLINDERS					
	KMCRL-4	1 1/4" 6-pin "0 Bitted" Mortise Cylinder, comes with Adams Rite Cam. Other cams are available as HSK Includes 2 keys. OPTIONAL RIM PACK	80.11		
	RIM PACK	Mortise-Rim Combo component parts pack	5.81		
KEY BLANKS					
	KBCRL-6	Key Blanks for use with Full Size replacement cylinders 50 pieces per box	5.21		
	KBCRS-7	Key blanks for use with 7PUCCRS Small Format Interchangeable Cores. 50 pieces per box			
TAILPIECE KIT					
	KT-H-PK	<ul style="list-style-type: none"> • KIKLCAP-01 • KIKLCAP-02 • LZTPSD-01 • LZTPDD-01 • LZTPDD-02 • TPWASHER • KIKLZTP-01 • KIKLZTP-02 • KIKLZTP-03 • KIKLZTP-04 • KIKLZTP-05 • KIKLZTP-06 	19.91	---	

► For KEYING charges see page L115

CRP HSK HIGH SECURITY *List Price*

EXCLUSIVE PATENTED SIDE BAR KEYWAY

MEETS
The Buy American Act

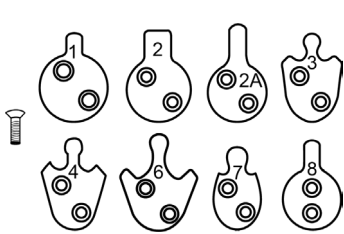

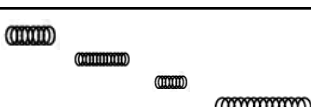
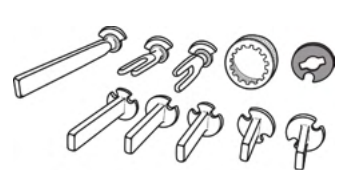
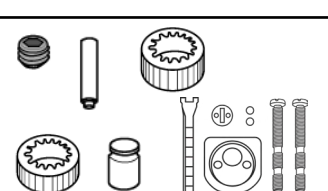

ILLUSTRATION	ITEM #	DESCRIPTION	LIST PRICE EA.	FINISH
	KIKL5 (Includes 2 Keys and all Tailpieces & Caps shown)	Universal 5-pin Grade 3 0-bitted 0B Key-In-Knob / Lever & Deadbolt Cylinder	\$103.57	US26D, US3
		Universal 5-pin Keyed Different KD Grade 3 Key-In-Knob / Lever & Deadbolt Cylinder	114.71	
	KIKL6 (Includes 2 Keys and all Tailpieces & Caps shown)	UL-Listed Universal 6-pin 0-bitted 0B Key-In-Knob / Lever & Deadbolt Cylinder	103.57	
		UL-Listed Universal 6-pin Keyed Different KD Key-In-Knob / Lever & Deadbolt Cylinder	114.71	
	ULKIKL (Includes 2 Keys and all Tailpieces & Caps shown)	UL-Listed Universal 6-pin 0-bitted 0B Key-In-Knob / Lever & Deadbolt Cylinder	140.54	
		UL-Listed Universal 6-pin Keyed Different KD Key-In-Knob / Lever & Deadbolt Cylinder	147.89	
	LFIC6 (Includes 2 Keys)	6-pin 0-bitted 0B Schlage Large Format Interchangeable Core	146.70	
		6-pin Keyed Different KD Schlage Large Format Interchangeable Core	164.00	
	ULLFIC6 (Includes 2 Keys)	UL-Listed 6-pin "A" 0-bitted 0B Schlage Large Format Interchangeable Core	182.49	
		UL-Listed 6-pin "A" Keyed Different KD Schlage Large Format Interchangeable Core	193.51	
	SFIC7 (Includes 2 Keys)	7-pin 0-bitted 0B Small Format Interchangeable Core Cylinder	120.87	
		7-pin Keyed Different KD Small Format Interchangeable Core Cylinder	120.87	
	ANSFIC7 (Includes 2 Keys)	ANSI / BHMA A156.30 certified 7-pin 0-bitted 0B "A" Small Format Interchangeable Core Cylinder	152.87	
		ANSI / BHMA A156.30 certified 7-pin 0-bitted KD "A" Small Format Interchangeable Core Cylinder	161.52	
	MRC114 (Includes 2 Keys)	6-pin 1 1/4" 0-bitted 0B Mortise-Rim Combination Cylinder Rim Pack Included	120.87	US26D
		6-pin 1 1/4" 0-bitted KD Mortise-Rim Combination Cylinder Rim Pack Included	133.19	
	ULMRC114 (Includes 2 Keys)	UL-Listed 6-pin 1 1/4" "A" 0-bitted 0B Mortise-Rim Combination Cylinder Rim Pack Included	152.87	
		UL-Listed 6-pin 1 1/4" "A" Keyed Different KD Mortise-Rim Combination Cylinder Rim Pack Included	162.70	
	MRC118 (Includes 2 Keys)	6-pin 1 1/8" 0-bitted 0B Mortise-Rim Combination Cylinder Rim Pack Included	120.87	
		6-pin 1 1/8" Keyed Different KD Mortise-Rim Combination Cylinder (Rim Pack Included)	133.19	
	ULMRC118 (Includes 2 Keys)	UL-Listed 6-pin 1 1/8" "A" 0-bitted 0B Mortise-Rim Combination Cylinder. (Rim Pack Included)	152.87	
		UL-Listed 6-pin 1 1/8" "A" Keyed Different KD Mortise-Rim Combination (Rim Pack Included)	162.70	
MRCLFIC-2-H	Mortise-Rim Combination Small Format IC Housing Adams Rite Cam Standard (Rim Pack Included)	85.08		
MRCSFIC-1-H	Mortise-Rim Combination Small Format IC Housing Adams Rite Cam Standard (Rim Pack Included)	85.08		
	KBL5	5-pin sidebar keyway Key Blank For Key-In-Knob / Lever, Schlage LFIC and Mortise / Rim Cylinders	11.61	
	KBL6	6-pin sidebar keyway Key Blank For Key-In-Knob / Lever, Schlage LFIC and Mortise / Rim Cylinders	11.61	
	KBLSF7	7-pin sidebar keyway Key Blank For Small Format Interchangeable Core	11.61	
	KCK6	Schlage LFIC, 6-pin Key-In-Knob / Lever and Mortise / Rim Cylinder sidebar keyway Control Key	11.61	

► For KEYING charges see page L115

Standard Schlage Pinning kits are used for all cylinders except for Small Format, which uses Best pinning kits

CRP HSK HIGH SECURITY LIST Price

ACCESSORIES

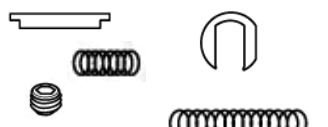
ILLUSTRATION	ITEM #	DESCRIPTION	PACK QUANTITY	LIST PRICE/PACK
MORTISE-RIM CYLINDER COMBO and Small Format IC Housing COMPONENTS (NON-UL)				
	CAMADAM-1	Adams Rite Cam	5	\$5.33
	CAMYALE-2	Yale Wide Cam	5	5.33
	CAMYALE-2A	Yale Standard Cam	5	5.33
	CAMRUSS-3	Corbin Russwin Cam	5	5.33
	CAMFLCN-4	Falcon Cam	5	5.33
	CAMCRP-6	Cal-Royal NM Series Mortise Lock Cam	5	5.33
	CAMSCHL-7	Schlage Cam	5	5.33
	CAMSGNT-8	Sargent Offset Cam	5	5.33
	CAMSCREW	Cam Screw	25	5.57
MORTISE AND KIKL CYLINDER COMPONENTS (NON-UL)				
	SIDEBAR-1	Side Bar	10	16.12
	SPIN1	Side Pin #1	10	16.59
	SPIN2	Side Pin #2	10	16.59
	SPIN3	Side Pin #3	10	16.59
	SPIN4	Side Pin #4	10	16.59
	SIDEBARSPRING	Spring for Side Bar	20	2.02
	KIKSPRING	Spring for Screw Cap	25	3.79
	MRTPINSPRING	Mortise Pin Spring	50	4.98
	KIKPINSPRING	Top Pin Spring	50	4.98
	LZTPSD-01	Lazy Tailpiece Long for Single Cylinder	10	23.70
	LZTPDD-01	Lazy Tailpiece Short for Double Cylinder Black	10	4.98
	LZTPDD-02	Lazy Tailpiece Short for Double Cylinder Gold	10	4.98
	TPWASHER	Black Washer to retain Long Tailpiece LZTPSD-01	10	9.72
	KIKLZTP-01	Lazy Tailpiece for Knob / Lever 5/8"	5	12.09
	KIKLZTP-02	Lazy Tailpiece for Knob / Lever 5/8"	5	12.09
	KIKLZTP-03	Lazy Tailpiece for Knob / Lever 7/8"	5	12.09
	KIKLZTP-04	Lazy Tailpiece for Knob / Lever 15/16"	5	12.09
	KIKLZTP-05	Lazy Tailpiece for Knob / Lever 1 5/32"	5	12.09
KIKLZTP-06	Lazy Tailpiece for Knob / Lever 1 5/32" Narrow Tip	5	17.54	
	ALLNSCRW-BLK	Allen Screw Black	25	5.57
	KIKPIN	Pin for Screw Cap	25	73.35
	KIKLCAP-01	KIKL Cap Long	10	52.85
	KIKLCAP-02	KIKL Cap Short	10	44.68
	MSHRMTPIN	Mushroom Top Pin	50	16.12
	RIM PACK	Mortise-Rim Combo component parts pack	1	5.81
	SMALL FORMAT INTERCHANGEABLE CORE (SFIC) CYLINDER HOUSING COMPONENTS			
	SFICSPIN1	SFIC Side Pin #1	10	16.59
	SFICSPIN2	SFIC Side Pin #2	10	16.59
	SFICSPIN3	SFIC Side Pin #3	10	16.59
	SFICSIDEBAR	SFIC Side Bar	10	16.12
	SFICCCCLIP	SFIC "C" Clip	25	14.22
	SFICSBSPR	SFIC Side Bar Spring	25	2.49
	SFICALLNSCRW	SFIC Allen Screw	25	39.46
	SFICSPR	SFIC Pin Spring	50	4.98

Standard Schlage Pinning kits are used for all cylinders except for Small Format, which uses Best pinning kits

MEETS
The Buy American Act

CRP HSK HIGH SECURITY LIST Price

ACCESSORIES

MEETS
The Buy American Act

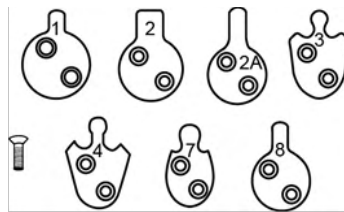
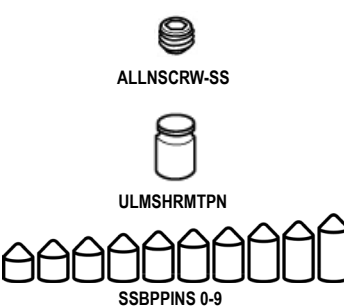
ILLUSTRATION	ITEM #	DESCRIPTION	PACK QUANTITY	LIST PRICE/PACK
LARGE FORMAT INTERCHANGEABLE CORE (LFIC) CYLINDER HOUSING COMPONENTS				
	LFCAMADAM-1	LFIC Adams Rite Cam	5	\$19.67
	LFCAMYALE-2	LFIC Yale Wide Cam	5	19.67
	LFCAMYALE-2A	LFIC Yale Standard Cam	5	19.67
	LFCAMRUSS-3	LFIC Corbin Russwin Cam	5	19.67
	LFCAMFLCN-4	LFIC Falcon Cam	5	19.67
	LFCAMSCHL-7	LFIC Schlage Cam	5	19.67
	LFCAMSCRW	LFIC Cam Screw	15	5.45
MORTISE-RIM CYLINDER COMBO and Small Format IC Housing COMPONENTS (UL-LISTED)				
	ULCAMADAM-1	UL-Listed Adams Rite Cam	5	19.67
	ULCAMYALE-2	UL-Listed Yale Wide Cam	5	19.67
	ULCAMYALE-2A	UL-Listed Yale Standard Cam	5	19.67
	ULCAMRUSS-3	UL-Listed Corbin Russwin Cam	5	19.67
	ULCAMFLCN-4	UL-Listed Falcon Cam	5	19.67
	ULCAMSCHL-7	UL-Listed Schlage Cam	5	19.67
	ULCAMSGNT-8	UL-Listed Sargent Offset Cam	5	19.67
	CAMSCREW	Cam Screw	25	5.57
MORTISE AND KIKL CYLINDER COMPONENTS (UL-LISTED)				
	ALLNSCRW-SS	Allen Screw Stainless Steel	25	27.73
	ULMSHRMTPIN	UL-Listed Mushroom Top Pin	50	45.62
	SSBPIN0	Stainless Steel Bottom Pin#0	12	4.62
	SSBPIN1	Stainless Steel Bottom Pin#1	12	4.62
	SSBPIN2	Stainless Steel Bottom Pin#2	12	4.62
	SSBPIN3	Stainless Steel Bottom Pin#3	12	4.62
	SSBPIN4	Stainless Steel Bottom Pin#4	12	4.62
	SSBPIN5	Stainless Steel Bottom Pin#5	12	4.62
	SSBPIN6	Stainless Steel Bottom Pin#6	12	4.62
	SSBPIN7	Stainless Steel Bottom Pin#7	12	4.62
	SSBPIN8	Stainless Steel Bottom Pin#8	12	4.62
	SSBPIN9	Stainless Steel Bottom Pin#9	12	4.62
	OTHER ACCESSORIES			
SEE NEXT PAGE	REGCARD	High Security Plastic Registration Card	10	56.76
	KITPARTS-1	Parts Kit for CRP High Security	1	358.34
	KITSTDPIN-2	Standard Pin Kit for CRP High Security	1	277.41
	KITULPIN-3	UL-Pinning Kit for CRP High Security	1	197.42
	KITULPIN-4	UL-Parts Kit for CRP High Security	1	407.29
	KITSFICPARTS-5	SFIC Parts	1	218.04
	KITCAMS-6	Small & Large Format Cams UL & Non-UL	1	365.10

Standard Schlage Pinning kits are used for all cylinders except for Small Format, which uses Best pinning kits

CRP HSK HIGH SECURITY LIST Price

ACCESSORIES

MEETS
The Buy American Act

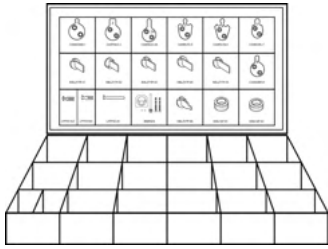
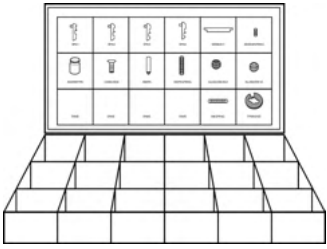
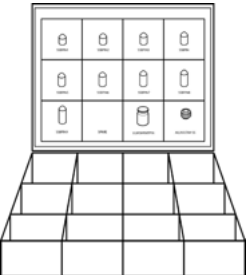
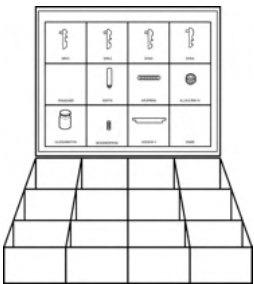
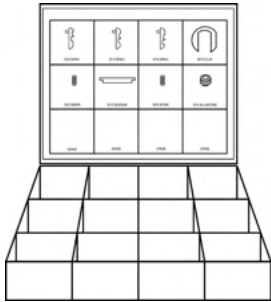
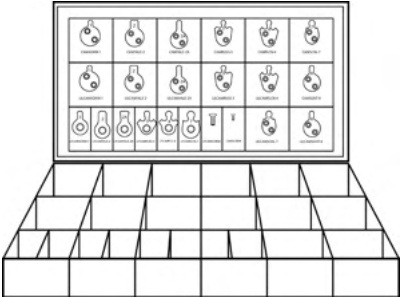
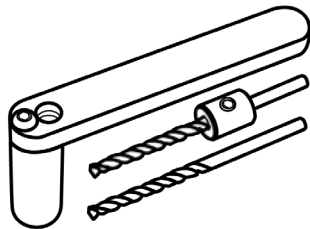
<p>KITPARTS-1 \$358.34</p>  <p>CAMADAM-1 x 10, CAMYALE-2 x 10, CAMYALE-2A x 10, CAMRUSS-3 x 10, CAMFLCN-4 x 10, CAMSCHL-7 x 10, CAMSGNT-8 x 10, KIKLCAP-01 x 10, KIKLCAP-02 x 10, RIMPACK x 2, KIKLZTP-01 x 5, KIKLZTP-02 x 5, KIKLZTP-03 x 5, KIKLZTP-04 x 5, KIKLZTP-05 x 5, KIKLZTP-06 x 5, LZTPDD-BLK x 20, LZTPDD-GLD x 20, LZTPSD-01 x 10</p>	<p>KITSTDPIN-2 \$277.41</p>  <p>ALLNSCRW-SS x 25, ALLNSCRW-BLK x 25, KIKPINSRING x 100, KIKSPRING x 25, CAMSCREW x 25, SIDEBAR-1 x 10, MSHRMTPIN x 50, KIKPIN x 25, SPIN1 x 10, SPIN2 x 10, SPIN3 x 10, SPIN4 x 10, TPWASHER x 10, SIDEBARSRING x 20</p>	
<p>KITULPIN-3 197.42</p>  <p>SSBPIN0 x 24, SSBPIN1 x 24, SSBPIN2 x 24, SSBPIN3 x 24, SSBPIN4 x 24, SSBPIN5 x 24, SSBPIN6 x 24, SSBPIN7 x 24, SSBPIN8 x 24, SSBPIN9 x 24, ULMHRMTPIN x 50, ALLNSCRW-SS x 25</p>	<p>KITULPIN-4 407.29</p>  <p>SPIN1 x 20, SPIN2 x 20, SPIN3 x 20, SPIN4 x 20, TPWASHER x 20, KIKPIN x 25, KIKSPRING x 25, ALLNSCRW-SS x 25, ULMHRMTPIN x 100, SIDEBARSRING x 20, SIDEBAR-1 x 10</p>	<p>KITSFICPARTS-5 218.04</p>  <p>SFICSPIN1 x 20, SFICSPIN2 x 20, SFICSPIN3 x 20, SFICCLIP x 25, SFICSPR x 50, SFICSIDEBAR x 10, SFICSBSPR x 25, SFICALLNSCRW x 25</p>
<p>KITCAMS-6 365.10</p>  <p>LFCAMADAM-1 x 5, LFCAMFLCN-4 x 5, LFCAMRUSS-3 x 5, LFCAMSCHL-7 x 5, LFCAMSCRW x 30, LFCAMYALE-2 x 5, LFCAMYALE-2A x 5, MRTPINSRING x 50, ULCAMADAM-1 x 5, ULCAMFLCN-4 x 5, ULCAMRUSS-3 x 5, ULCAMSCHL-7 x 5, CAMSCREW x 25, ULCAMSGNT-8 x 5, ULCAMYALE-2 x 5, ULCAMYALE-2A x 5, CAMADAM-1 x 5, CAMYALE-2 x 5, CAMYALE-2A x 5, CAMRUSS-3 x 5, CAMFLCN-4 x 5, CAMSCHL-7 x 5, CAMSGNT-8 x 5</p>	<p>KZHSK COT 547.83</p>  <p>DRIVE PIN CUT OFF TOOL (Used for converting regular SFIC Housing for use with HSK SFIC Cylinders)</p>	

CRP HSK HIGH SECURITY LIST Price

STOCK ITEM PRICES IN BOLD
NON-STOCK FINISHES AND DESIGNS AVAILABLE WITH FACTORY LEAD TIME
AND SUBJECT TO MINIMUM ORDER

HSK HEAVY DUTY GRADE 1 DEADBOLTS

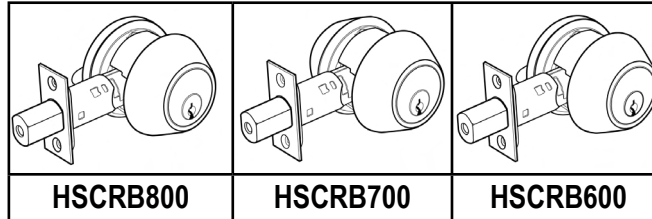

FUNCTION	ANSI	ITEM #	US26D	US3, 15	US10B	US4, 5, 26	PCS / MC
Grade 1, UL Listed, "HSK" Keyway Single Cylinder Deadbolt	E0152	HSCRB800	\$289.85	\$289.85	\$295.07	\$295.07	20
Grade 1, UL Listed, "HSK" Keyway Double Cylinder Deadbolt	E0142	HSCRB700	334.29	334.29	339.50	339.50	
Classroom Deadbolt lock, Deadbolt thrown or retracted by key outside. Inside turn unit will retract bolt only. Bolt automatically deadlocks when fully thrown	F109	HSCRB600	295.07	295.07	300.28	300.28	

HSK HEAVY DUTY GRADE 2 DEADBOLTS

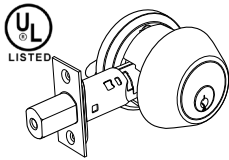
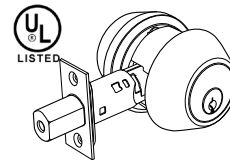
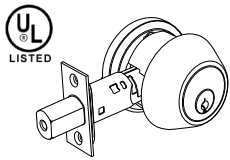
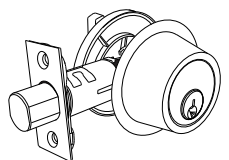
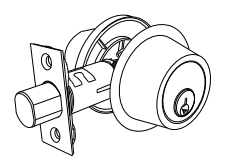
UL-LISTED			NON-UL	
				
HSULT360 / HSCL600	HSULT362	HSULT700	HSCB160	HSCB162

FUNCTION	ANSI	ITEM #	US3	US26D	US10B	US4	US15	US26, US10	US5	PCS / MC
Heavy Duty Single Cylinder Deadbolt, UL Listed	E0152	HSULT360	\$228.11	\$228.11	\$236.53	\$251.58	\$230.84	\$228.11	\$232.97	20
Heavy Duty Double Cylinder Deadbolt, UL Listed	E0142	HSULT362	267.93	267.93	289.50	271.01	271.01	264.26	272.91	
Classroom deadbolt lock UL Listed	E0172	HSCL600	262.36	262.36	268.40	262.36	262.36	262.36	262.36	
One-Way Deadbolt Lock UL Listed	E1161	HSULT700	221.95	221.95	232.73	232.73	232.73	232.73	232.73	
Heavy Duty Single Cylinder Deadbolt	E0152	HSCB160	203.58		208.80					36
Heavy Duty Double Cylinder Deadbolt	E0142	HSCB162	229.77		234.99					

► For KEYING charges see page L115

CRP COMBI KEY SYSTEM *List Price*

EXCLUSIVE PATENTED COMBINATION KEYWAY

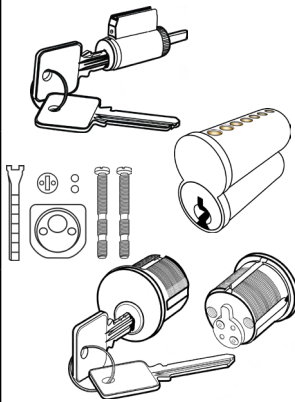
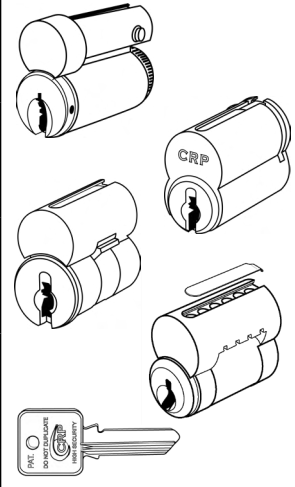
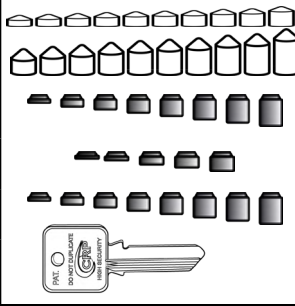
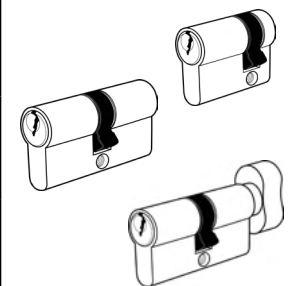
ILLUSTRATION	ITEM #	DESCRIPTION	LIST PRICE EA.	FINISH	
	KK-COS-NS (Includes 2 Keys and all Tailpieces & Caps shown)	Key-In-Knob / Lever Replacement Cylinder, 6-pin "0-bitted". Includes 2 keys / Lever Tailpiece. (other tailpieces available on request)	\$53.33	US26D	
	6PUC-COS (NO keys included)	Uncombined Small Format Interchangeable Core Conventional SFIC, 6-pins. Does not include keys.	68.73		
	KM-COS-4 (Includes 2 Keys and all Tailpieces & Caps shown)	1 1/4" 6-pin "0-bitted" Mortise Cylinder. Cylinder comes with Adams Rite Cam - other cams are available as HSK. Optional Rim Conversion Package available. See page L107 (RIM PACK) . Includes 2 keys.	77.03		
	KL-COS-SC (Includes 2 Keys)	Schlage Large Format, 6-pin "0-bitted". Includes 2 keys.	109.02		
	KL-COS-YA (Includes 2 Keys)	Yale Combi 6-pin Large Format IC control key for Schlage and Yale Large Format 6-pin uncombined. Does not include keys.	109.02		
	KL-COS-SA (Includes 2 Keys)	Sargent Combi 6-pin Large Format IC control key for Schlage and Yale Large Format 6-pin uncombined. Does not include keys.	109.02		
	KL-COS-CR (Includes 2 Keys)	Corbin / Russwin Large Format uncombined. Does not include keys.	109.02		
	COSCK	Combi Control Key for LFIC (Schlage and Yale cores).	8.30		
	KP-I	Combi SFIC (Best / Falcon A-2 Pins)	14.22 / 100 pcs		
	KP-C2	Combi Large Diameter Cylinders (A-2 Pinning)	14.22 / 100 pcs		
	KP-I4	Combi SFIC (Best / Falcon A-4 Pins)	14.22 / 100 pcs		
	KP-C4	Combi Large Diameter Cylinders (A-4 Pinnings)	14.22 / 100 pcs		
	KBCOS6	Combi 6-pin key blank	6.16		
EUROPEAN PROFILE CYLINDERS					
	KE-COS-S (Includes 2 Keys)	1 3/4" (45mm) length, 6-pin standard, 0-bitted. 2 keys included. Half Cylinder	53.33		US26D
	KE-COS-D (Includes 2 Keys)	2 3/4" (70mm) length, 6-pin standard, 0-bitted. 2 keys included. Double Cylinder	106.65		
	KE-COS-C (Includes 2 Keys)	2 3/4" (70mm) length, 6-pin standard, 0-bitted. 2 keys included. Thumbturn Cylinder	88.88		

► For KEYING charges see page L115

CRP COMBI PINNING KITS *List Price*

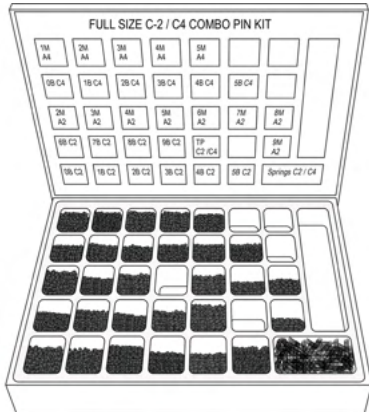

COMBI C2 / C4 Full Size Pinning Kit \$533.25 LIST
DUAL COMBI A2 / A4 / C2 / C4
Small Format & Full Size Pinning Kit \$793.95 LIST

CRP PINNING KIT FOR COMBI CYLINDERS

KP-I <ul style="list-style-type: none"> • SFIC pins for keying (same as BEST A2) 	KP-I4 <ul style="list-style-type: none"> • SFIC pins for keying (same as BEST A4) 	KP-C2 <ul style="list-style-type: none"> • Full size pins C2 large diameter cylinders 	KP-C4 <ul style="list-style-type: none"> • Full size pins C4 large format diameter cylinders
A2 SFIC PINS	A4 SFIC PINS	C2 FULL SIZE PINS	C4 FULL SIZE PINS
(2-19) Master Pins KP-I-2M KP-I-8M KP-I-14M KP-I-3M KP-I-9M KP-I-15M KP-I-4M KP-I-10M KP-I-16M KP-I-5M KP-I-11M KP-I-17M KP-I-6M KP-I-12M KP-I-18M KP-I-7M KP-I-13M KP-I-19M	(1-11) Master Pins <ul style="list-style-type: none"> • KP-I4-1M • KP-I4-6M • KP-I4-2M • KP-I4-8M • KP-I4-3M • KP-I4-9M • KP-I4-4M • KP-I4-10M • KP-I4-5M • KP-I4-11M 	(2-9) Master Pins <ul style="list-style-type: none"> • KP-C2-2M • KP-C2-6M • KP-C2-3M • KP-C2-7M • KP-C2-4M • KP-C2-8M • KP-C2-5M • KP-C2-9M 	(1-5) Master Pins <ul style="list-style-type: none"> • KP-C4-1M • KP-C4-2M • KP-C4-3M • KP-C4-4M • KP-C4-5M
 (0-9) Bottom Pins <ul style="list-style-type: none"> • KP-I-0B • KP-I-5B • KP-I-1B • KP-I-6B • KP-I-2B • KP-I-7B • KP-I-3B • KP-I-8B • KP-I-4B • KP-I-9B 	 (0-5) Bottom Pins <ul style="list-style-type: none"> • KP-I4-0B • KP-I4-3B • KP-I4-1B • KP-I4-4B • KP-I4-2B • KP-I4-5B 	 (0-9) Bottom Pins <ul style="list-style-type: none"> • KP-C2-0B • KP-C2-5B • KP-C2-1B • KP-C2-6B • KP-C2-2B • KP-C2-7B • KP-C2-3B • KP-C2-8B • KP-C2-4B • KP-C2-9B 	 (0-5) Bottom Pins <ul style="list-style-type: none"> • KP-C4-0B • KP-C4-3B • KP-C4-1B • KP-C4-4B • KP-C4-2B • KP-C4-5B

ACCESSORIES

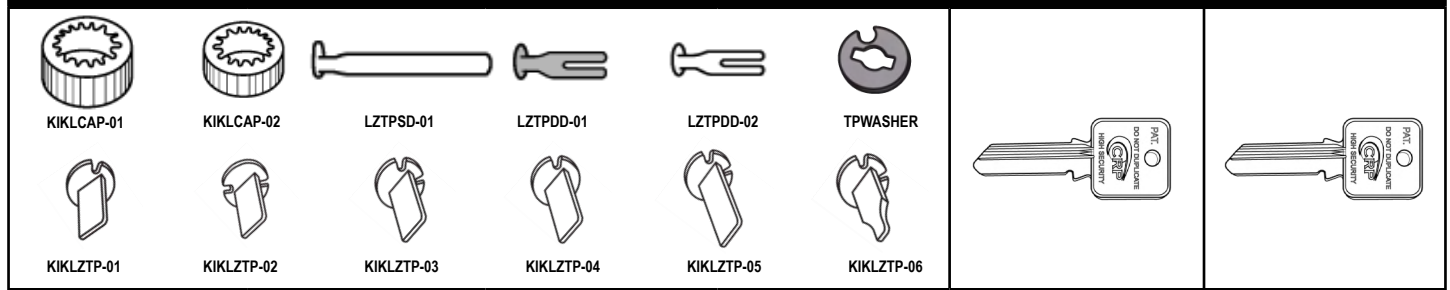

KT-H-PK <ul style="list-style-type: none"> • KIKLCAP-01 • KIKLCAP-02 • LZTPSD-01 • LZTPDD-01 • LZTPDD-02 • TPWASHER 	<div style="border: 1px solid black; padding: 5px; width: fit-content; margin: auto;"> SEE PAGE L109 FOR PRICING </div>	<ul style="list-style-type: none"> • KIKLZTP-01 • KIKLZTP-02 • KIKLZTP-03 • KIKLZTP-04 • KIKLZTP-05 • KIKLZTP-06 	KBCOS6 COMBI 6-pin key blank	COSCK COMBI 6-pin Large Format IC control key for Schlage and Yale
---	--	--	--	--

KEYS & KEYING ...

For Commercial Grade Locksets

COMMERCIAL LOCKSETS, CONVENTIONAL CYLINDER KEYING CHARGES (NOT INCLUDING RESIDENTIAL LOCKSETS)

ITEM #	DESCRIPTION	LIST PRICE
KA	Key Alike / 0-bitted	\$9.24/ <i>cylinder</i>
MK	Master Keying (Including KA charges)	18.49 / <i>cylinder</i>
GMK	Grand Master Keying (Including KA & MK charges)	23.70 / <i>cylinder</i>
GGMK	Grand Grand Master Keying (Including KA & MK charges)	32.00 / <i>cylinder</i>
CMK	Construction Master Keying (Including KA & MK charges) N/A on HSK & COMBI	29.03 / <i>cylinder</i>
KM	Key Marking letters or numbers (AA1, AA2, ...) on key bow or cylinder core	7.00/ <i>key</i>
DND	Do Not Duplicate	4.50 / <i>key</i>
CMARK	Cylinder Marking	8.30 / <i>cylinder</i>
ECK	Extra Cut Key (2 keys standard per lock)	4.27 / <i>key</i>
CECK	Extra Cut Combi Keys (2 keys standard per lock)	11.14 / <i>key</i>
HECK	Extra Cut High Security Keys (2 keys standard per lock) HSK	15.88 / <i>key</i>
CRSC15	Schalge "C" Key Blanks (5 pins)	1.19 / <i>key</i>
CRSC16	Schalge "C" Key Blanks (6-pins)	1.19 / <i>key</i>
CRKW1	Kwikset Key Blanks (5 pins)	1.19 / <i>key</i>

**2nd / 3rd Level
keying systems
will require
additional
charges**

**REQUEST
QUOTE**

**See Keying Policies
at our website
regarding keying
systems**

◆ **KEYING KITS**

KKC100	Keying Kit - "C" Keyway	282.03 / <i>ea.</i>
KKWI200	Keying Kit - KWI Keyway	

COMMERCIAL LOCKSETS INTERCHANGEABLE CORE (LFIC, SFIC) KEYS & KEYING CHARGES

ICKA	Key Alike / 0-bitted	30.10 / <i>cylinder</i>
ICMK	Master Keying (Including KA charges)	30.10 / <i>cylinder</i>
ICGMK	Grand Master Keying (Including KA & MK charges)	35.43 / <i>cylinder</i>
ICGGMK	Grand Grand Master Keying (Including KA, MK & GMK charges)	40.65 / <i>cylinder</i>
IECK	SFIC Extra Cut Keys	8.77 / <i>key</i>
CONKEY	Extra Cut Control Keys for Best Falcon and Arrow	8.77 / <i>key</i>
CONKEY-1	Extra Cut Control Keys for Schlage "C"	8.77 / <i>key</i>
CONKEY-2	Extra Cut Control Keys for Schlage "E"	8.77 / <i>key</i>
CONKEY-3	Extra Cut Control Keys for Yale "GA"	10.67 / <i>key</i>
KB-LF-GA	Control Key Blank for Yale "GA"	7.11 / <i>key</i>
KB-LF-SC	Control Key Blank for Schlage "C"	5.33 / <i>key</i>
KB-LF-SE	Control Key Blank for Schlage "E"	5.33 / <i>key</i>

Two control keys are
supplied with each Masterkey
System at no charge

For HSK, CRL, CRS and COMBI Cylinders see HSK Service Manual on our website

OTHER ACCESSORIES

ITEM #	DESCRIPTION	LIST PRICE
PDBFLS	Plastic Dust box for Full Lip Strike	\$3.32
PDB1214	Plastic Dust box for Residential Deadbolt Strike 1" x 2 1/4"	
PDB118234	Plastic Dust box for T-Strike 1 1/8" x 2 3/4"	
PDBTS	Plastic Dust box for Deadbolt T2STRK Strike	6.52
PDB478	Plastic Dust box for ASA Strike	
LFA18	Latch front adapter to convert 1" plate to 1 1/8" wide door preparations (Clear)	0.71

RESIDENTIAL KEYING *List Price*

KEYING CHARGES		
ITEM #	DESCRIPTION	LIST PRICE
KARES	Key alike	\$5.81
MKRES	Master key (Including KA charges)	7.35
CMKRES	Builder construction master key (Including KA & MK Charges)	10.19
GMKRES	Grand master key (Including KA, MK)	13.15