

HINGES

Price List 2017

CAL-ROYAL
P R O D U C T S , I N C . U . S . A .



TABLE OF CONTENTS

I. COMMERCIAL HINGES

HEAVY WEIGHT

Four Ball Bearings (5" x 5", 5" x 4 1/2", 5" x 4", 4 1/2" x 4 1/2", 4 1/2" x 4")..... H1

STANDARD WEIGHT

Two Ball Bearings (5" x 5", 5" x 4 1/2", 5" x 4", 4 1/2" x 4 1/2", 4 1/2" x 4")..... H1-H2
 Plain Bearing (5" x 5" 4 1/2" x 4 1/2", 4 1/2" x 4", 4" x 4")..... H2-H3

II. MADE IN TAIWAN HINGES THAT MEETS THE BUY AMERICAN ACT

HEAVY WEIGHT

Four Ball Bearing (4 1/2" x 4 1/2")..... H2

STANDARD WEIGHT

Two Ball Bearings (4 1/2" x 4 1/2", 5" x 4 1/2")..... H2

III. SOLID BRASS HINGES

HEAVY WEIGHT

Four Ball Bearing (4 1/2" x 4 1/2")..... H4

STANDARD WEIGHT

Plain Bearing (3 1/2" x 3 1/2", 3" x 3", 4 1/2" x 4 1/2", 4" x 4")..... H4
 Two Ball Bearing (4 1/2" x 4 1/2")..... H4

IV. DECORATIVE TIPS HINGES

EXTRUDED SOLID BRASS HINGES

Acorn Tip..... H8
 Ball Tip..... H8
 Steeple Tip..... H8
 Urn Tip..... H8

STEEL PLATED COMMERCIAL HINGES

Ball Tip (3 1/2" x 3 1/2", 3" x 3", 4 1/2" x 4 1/2", 4" x 4", 5" x 5")..... H3-H4
 Steeple Tip (3 1/2" x 3 1/2", 3" x 3", 4 1/2" x 4 1/2", 4" x 4", 5" x 5")..... H4

STEEL PLATED RESIDENTIAL HINGES

Ball Tip (3 1/2" x 3 1/2", 4" x 4")..... H11
 Steeple Tip (3 1/2" x 3 1/2", 4" x 4")..... H11

V. SPECIALTY HINGES

Concealed Ball Bearings (4 1/2" x 4 1/2", 5" x 5")..... H4
 Full Surface (4 1/2")..... H5
 Half Mortise (4 1/2")..... H5
 Half Surface (4 1/2")..... H5
 Hospital Tip Hinges (4 1/2" x 4 1/2"), (5" x 4 1/2")..... H5
 Swing Clear Hinges (3 1/2" x 3 1/2", 4 1/2" x 4 1/2", 4" x 4")..... H5
 Wide Throw Hinges (4 1/2" x 6")..... H5

VI. ELECTRIFIED HINGES

Two Ball Bearings (4 1/2" x 4 1/2")..... H6
 Four Ball Bearings (4 1/2" x 4 1/2", 5" x 4 1/2")..... H6
 Concealed Ball Bearing (4 1/2" x 4 1/2")..... H6

VII. SPRING HINGES

Standard Weight (4 1/2" x 4 1/2", 4 1/2" x 4")..... H6
 Round Corner, .110"Gauge (4" x 4")..... H7
 Benchmark, Round Corner, .110"Gauge (4" x 4")..... H7
 New Spring Hinges (3 1/2" x 3 1/2", 4" x 4")..... H7

VIII. CASTLEGATE COMBINATION HINGES

Corner Spring Hinges (5/8")..... H7
 Corner Hinges (5/8")..... H10

IX. EXTRUDED SOLID BRASS HINGES

Two Ball Bearings (3 1/2" x 3 1/2", 4 1/2" x 4 1/2", 4" x 4")... H7-H8
 Plain Ball Bearing (3 1/2" x 3 1/2", 4 1/2" x 4 1/2", 4" x 4")... H8

X. RESIDENTIAL HINGES

RESIDENTIAL WEIGHT

Plain Bearing-Template (3 1/2" x 3 1/2", 4" x 4")..... H8
 Two Ball Bearings (3 1/2" x 3 1/2", 4" x 4")..... H8-H9
 Plain Bearing (3 1/2" x 3 1/2", 4" x 4")..... H9-H10
 Benchmark, Round Corner (5/8")..... H10
 Plain Bearing, Stainless Steel Square Corner (3 1/2" x 3 1/2", 3" x 3", 4" x 4")..... H11

XI. SOLID BRASS PARLIAMENT HINGES

3" x 2 1/4"..... H11
 4 5/8" x 2 1/2"..... H11
 4" x 2 1/2"..... H11

XII. REINFORCING PIVOT HINGES

Full Surface (4 1/2")..... H11

XIII. CABINET HINGES

2 1/2" x 1 11/16"..... H11
 2" x 1 1/2"..... H11

XIV. HINGE SCREWS

Steel Screws for Contract Grade Size 4", 4.5", 5"..... H12
 Steel Screws for Residential Hinges (4" x 4", 3 1/2" x 3 1/2")..... H12
 Steel Screws for TBHRC33 and TBHRC45, 4" x 4", 3 1/2" x 3 1/2" Timely Hinges, 4" x 4" and 3 1/2" x 3 1/2"
 Spring Hinges, 3 1/2" x 3 1/2" Contract Grade Hinges..... H12

XV. GEARED ALUMINUM CONTINUOUS HINGES

Concealed Leaf (83", 95")..... H13
 Full Surface (83", 95")..... H13
 Half Surface (83", 95")..... H13
 Additional Heavy Duty Channel Cover (83", 95")..... H14
 Electrification (83", 95")..... H14

HINGES

LIST PRICES OCT 2017

All hinges shown are stock items in US. Designs, sizes and finishes not shown in price list are available subject to quantity and minimum order and lead time.

All hinges are stamped with CRP logo. Finishes in **REVERSE BOLD ITALICS** are also available w/o logo. Prefix "UN" when ordering.

NOTES

- All hinges are sold with a minimum order quantity (MOQ) equal to or exactly divisible by the inner box quantity.
- **N.R.P.** (Non-Removable Pin) where not shown **ADD \$2.80 / Each List.**
- **N.R.P.** for **US32D** **ADD \$5.57 / Each List.**

ITEM#	SIZE	FINISH	LIST PRICE	BOX QTY	CASE QTY
HEAVY WEIGHT, BALL BEARING HINGES					
Full Mortise, Heavy Weight, Four Ball Bearings UNIT / EACH					
BB5500	5" x 5"	US26DNRP	\$49.00		
		US32D	107.00		
		US32DNRP	111.90	3	48
		US10B	57.74		
		US10BNRP	60.48		
BB5210	5" x 4 1/2"	USP	42.90		
		US26D	46.60		
		US26DNRP	49.10		
		US10	51.50		
		US10A	51.50		
		US10B	51.50		
		US10BNRP	54.00	3	48
		US3	51.50		
		US4	46.60		
		US26	51.50		
		US32D	94.40		
		US32DNRP	99.30		
BB5254	5" x 4"	USP	42.90		
		US26D	46.40		
		US10A	51.50	3	48
		US10B	51.50		
		US32D	94.40		
BB5200	4 1/2" x 4 1/2"	USP	33.04		
		US26DNRP	33.44		
		US10A	39.70		
		US10B	39.70		
		US10BNRP	42.20	3	48
		US10	33.10		
		US4	33.10		
		US3	39.70		
		US26	39.70		
		US32DNRP	65.55		
BB52454	4 1/2" x 4"	USP	33.10		
		US26D	30.88		
		US26DNRP	33.44		
		US10A	39.70		
		US4	33.10	3	48
		US3	39.70		
		US26	39.70		
		US32D	68.40		
		US32DNRP	65.60		

• Other sizes and finishes available up to 8" x 8" upon request. All hinges above are steel base material with the exception of US32D (STAINLESS STEEL).

• For solid brass base, prefix "SB" before PART #

• Price and availability on application. (Subject to lead time and quantity)

ITEM#	SIZE	FINISH	LIST PRICE	BOX QTY	CASE QTY
STANDARD WEIGHT, BALL BEARING HINGES					
Full Mortise, Standard Weight, Two Ball Bearings UNIT / EACH					
RCBB31	4 1/2" x 4 1/2"	US26DNRP	\$18.10		
	1/4" Radius	US10BNRP	20.90	3	48
		US32DNRP	44.68		
BB55	5" x 5"	US26D	29.50		
		US26DNRP	31.90		
		US3	41.70		
		US4	38.30		
		US26	41.70	3	48
		US10	38.30		
		US10B	38.30		
		US32D	93.10		
BB545	5" x 4 1/2"	USP	22.10		
		US26D	26.50		
		US26DNRP	29.00		
		US26	36.80		
		US4	31.40		
		US10	31.40	3	48
		US10A	31.40		
		US10B	31.40		
		US3	36.80		
		US32D	66.20		
		US32DNRP	71.10		
BB54	5" x 4"	USP	22.10		
		US26D	26.50		
		US10A	31.40	3	48
		US3	36.80		
		US32D	66.20		
BB31	4 1/2" x 4 1/2"	USP	10.80		
		USPNRP	12.30		
		US26D	15.60		
		US26DNRP	17.10		
		US10A	17.00		
		US10ANRP	19.40		
		US10B	18.40		
		US10BNRP	20.90		
		US10	15.20		
		US10NRP	17.70		
		US15A	17.00		
		US15	17.00		
		US15NRP	19.40	3	48
		US4	14.00		
		US4NRP	16.50		
		US3	20.60		
		US3NRP	23.10		
		US5	17.00		
		US26	20.60		
		US26NRP	23.10		
		DURO	13.00		
		US1	13.00		
		US1NRP	15.50		
		US32D	44.10		
		US32DNRP	49.00		

All hinges shown are stock items in US. Designs, sizes and finishes not shown in price list are available subject to quantity and minimum order and lead time.

All hinges are stamped with CRP logo. Finishes in **REVERSE BOLD ITALICS** are also available w/o logo. Prefix "UN" when ordering.

NOTES

- All hinges are sold with a minimum order quantity (MOQ) equal to or exactly divisible by the inner box quantity.
- N.R.P.** (Non-Removable Pin) where not shown **ADD \$2.80 / Each List.**
- N.R.P.** for **US32D** **ADD \$5.57 / Each List.**

ITEM#	SIZE	FINISH	LIST PRICE	BOX QTY	CASE QTY
STANDARD WEIGHT, BALL BEARING HINGES					
Full Mortise, Standard Weight, Two Ball Bearings					
UNIT / EACH					
BB454	4 1/2" x 4"	USP	\$10.80		
		US26D	9.78		
		US26DNRP	10.82		
		US10A	17.00		
		US10B	17.00		
		US4	14.00	3	48
		US3	20.60		
		US26	20.60		
		US32D	30.33		
		US1	13.00		
	US1BLKNRP	15.50			
	US32DNRP	30.33			
BBSC56	4" x 4"	USP	11.30		
		US1	17.20		
		US26D	12.80		
		US10	16.00		
		US10A	16.00		
		US15A	16.00		
		US10B	16.00	3	48
		US15	16.00		
		US4	12.80		
		US3	18.40		
	US5	16.00			
	US26	18.40			
	US32D	38.00			
RCBB454	4 1/2" x 4" 1/8" Radius	US1BNRP US26DNRP	17.10 17.10	3	48
BBRC45	4" x 4" 1/4" Radius Template	USP	11.30		
		US1	17.20		
		US26D	12.80		
		US26DNRP	15.20		
		US10	16.00		
		US10A	16.00		
		US10ANRP	18.40		
		US15A	16.00		
		US10B	16.00		
		US10BNRP	18.40	3	48
		US15	16.00		
		US15NRP	18.40		
		US4	12.80		
		US3	18.40		
US5	16.00				
US26	18.40				
US32D	32.30				
DURO	14.70				
BBRC5844	4" x 4" 5/8" Radius Non Template	US26D	12.80		
		US15A	16.00		
		US10B	16.00		
		US15	16.00	3	48
		US4	12.80		
		US3	18.40		
		US26	18.40		

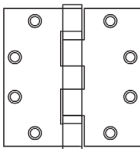
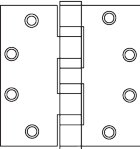
ITEM#	SIZE	FINISH	LIST PRICE	BOX QTY	CASE QTY
STANDARD WEIGHT, BALL BEARING HINGES					
Full Mortise, Standard Weight, Two Ball Bearings					
UNIT / EACH					
BBSC77	3 1/2" x 3 1/2"	USP	\$11.30		
		US26D	12.80		
		US10A	16.00		
		US10B	16.00	2	100
		US4	12.80		
		US5	16.00		
		US3	18.40		
		US32D	34.30		
BBRC5835	3 1/2" x 3 1/2" 5/8" Radius	US26D	14.50	2	100
BBSC33	3" x 3"	US32D	24.00	2	100
<ul style="list-style-type: none"> Other sizes and finishes available up to 6" x 6" upon request. All hinges above are steel base material with the exception of US32D (STAINLESS STEEL). For solid brass base, prefix "SB" before PART # Price and availability on application. (Subject to lead time and quantity) 					
Made In TAIWAN Hinges That Meets THE BUY AMERICAN ACT					
Full Mortise, Standard Weight, Two Ball Bearings					
UNIT / EACH					
TABB31	4 1/2" x 4 1/2"	US26D	19.60		
		US26DNRP	22.10	3	48
		US32DNRP	61.30		
 <div style="border: 1px solid black; padding: 5px; display: inline-block; text-align: center;"> MADE IN TAIWAN HINGES <i>That meet</i> THE BUY AMERICAN ACT </div>					
TABB545	5" x 4 1/2"	US26D	31.90		
		US32D	83.30	3	48
Full Mortise, Heavy Weight, Four Ball Bearings					
UNIT / EACH					
TABB5200	4 1/2" x 4 1/2"	US26DNRP	49.00		
		US32DNRP	88.20	3	48
 <div style="border: 1px solid black; padding: 5px; display: inline-block; text-align: center;"> MADE IN TAIWAN HINGES <i>That meet</i> THE BUY AMERICAN ACT </div>					
STANDARD WEIGHT, PLAIN BEARING HINGES					
Full Mortise, Standard Weight, Plain Bearing					
UNIT / EACH					
TBH55	5" x 5"	US3	32.90		
		US4	24.30		
		US10	32.00		
		US10B	32.00	3	48
		US26	32.90		
		US26D	24.30		
		US32D	82.70		
		TBH30	4 1/2" x 4 1/2"	USP	7.40
USPNRP	8.60				
US26D	9.90				
US26DNRP	11.30				
US10A	11.00				
US10B	12.10				
US15A	11.00				
US15	11.00				
US15NRP	13.40			3	48
US10	9.20				
US5	13.50				
US4	8.30				
US3	13.50				
US26	13.50				
DURO	8.10				
US32D	31.20				
US32DNRP	36.80				

HINGES

LIST PRICES OCT 2017

All hinges shown are stock items in US. Designs, sizes and finishes not shown in price list are available subject to quantity and minimum order and lead time.

All hinges are stamped with CRP logo. Finishes in **REVERSE BOLD ITALICS** are also available w/o logo. Prefix "UN" when ordering.

NOTES

- All hinges are sold with a minimum order quantity (MOQ) equal to or exactly divisible by the inner box quantity.
- **N.R.P.** (Non-Removable Pin) where not shown **ADD \$2.80 / Each List.**
- **N.R.P** for **US32D** **ADD \$5.57 / Each List.**

ITEM#	SIZE	FINISH	LIST PRICE	BOX QTY	CASE QTY
STANDARD WEIGHT, PLAIN BEARING HINGES					
Full Mortise, Standard Weight, Plain Bearing UNIT / EACH					
TBH454	4 1/2" x 4	US26D	\$9.90		
		US10A	11.00		
		US10	11.00		
		US4	8.30	3	48
		US3	13.50		
		US26	13.50		
		US32D	36.80		
TBHSC55	4" x 4"	USP	7.40		
		US1	9.90		
		US26D	9.90		
		US26DNRP	12.30		
		US10	12.30		
		US10A	12.30		
		US15A	12.30		
		US10B	12.30	3	48
		US10BNRP	14.70		
		US15	12.30		
		US4	9.40		
		US3	13.50		
		US5	12.30		
		US26	13.50		
		US32D	31.90		
		US32DNRP	36.80		
TBHRC44	4" x 4" 1/4" Radius	USP	7.40		
		US1	9.90		
		US26D	9.90		
		US26DNRP	12.30		
		US10	12.30		
		US10A	12.30		
		US10B	12.30		
		US10BNRP	14.80		
		US15A	12.30	3	48
		US15	12.30		
		US15NRP	14.80		
		US4	14.80		
		US3	13.50		
		US5	12.30		
		US26	13.50		
		DURO	9.90		
TBHRC5844	4" x 4" 5/8" Radius	US3	13.50	3	48

ITEM#	SIZE	FINISH	LIST PRICE	BOX QTY	CASE QTY
STANDARD WEIGHT PLAIN BEARING HINGES					
Full Mortise, Standard Weight, Plain Bearing UNIT / EACH					
TBHSC77	3 1/2" x 3 1/2"	USP	\$5.40		
		US1	8.90		
		US26D	7.90		
		US10A	9.10		
		US15A	9.10		
		US10B	9.10		
		US15	9.10		
		US4	7.90	2	100
		US3	11.10		
		US5	9.10		
		US26	11.10		
		US10	8.90		
		US32D	29.50		
		US32DNRP	34.30		
TBHRC66	3 1/2" x 3 1/2" 1/4" Radius	USP	7.40		
		US1	8.90		
		US26D	9.90		
		US10A	11.10		
		US10B	11.10		
		US15	11.10	2	100
		US15A	11.10		
		US4	9.90		
		US3	11.10		
		US5	11.10		
		US26	11.10		
TBHSC33	3" x 3"	US26D	6.40		
		US10A	9.10		
		US10B	9.10		
		US15	9.10		
		US15A	9.10	2	100
		US26	9.10		
		US3	9.10		
		US32D	13.80		
<ul style="list-style-type: none"> • Other sizes and finishes available up to 6" x 6" upon request. All hinges above are steel base material with the exception of US32D (STAINLESS STEEL). • For solid brass base, prefix "SB" before PART # • Price and availability on application. (Subject to lead time and quantity) 					
DECORATIVE TIPS FOR STEEL PLATED COMMERCIAL HINGES					
BALL TIP			UNIT / EACH	PRICE INCLUDES: 1 PIN & 2 TIPS	
BALL33KIT		US3			
	Ball Tip	US5			
	Commercial	US10B			
	3" x 3"	US15	6.55	2	100
	TBHSC33	US15A			
	&	US26			
	BBSC33	US26D			
BALL35KIT		US3			
	Ball Tip	US5			
	Commercial	US10B			
	3 1/2" x 3 1/2"	US15	6.55	2	100
	TBHSC77,	US15A			
	TBHRC66	US26			
	&	US26D			
	BBSC77	US26D			

All hinges shown are stock items in US. Designs, sizes and finishes not shown in price list are available subject to quantity and minimum order and lead time.

All hinges are stamped with CRP logo. Finishes in **REVERSE BOLD ITALICS** are also available w/o logo. Prefix "UN" when ordering.

NOTES

- All hinges are sold with a minimum order quantity (MOQ) equal to or exactly divisible by the inner box quantity.
- N.R.P.** (Non-Removable Pin) where not shown **ADD \$2.80 / Each List.**
- N.R.P.** for **US32D** **ADD \$5.57 / Each List.**

ITEM#	SIZE	FINISH	LIST PRICE	BOX QTY	CASE QTY			
DECORATIVE TIPS FOR STEEL PLATED COMMERCIAL HINGES								
BALL TIP UNIT / EACH								
BALL44KIT	Ball Tip Commercial 4" x 4"	US3 US5 US10B	\$6.55	2	100			
	TBHC44,	US15						
	TBHSC55,	US15A						
	BBSC56,	US26						
	BBRC45, BRC5844	US26D						
BALL45KIT	Ball Tip Commercial 4 1/2" x 4 1/2"	US3 US5 US10B	6.55	2	100			
	TBH30,	US15						
	TBH454,	US15A						
	BB31,	US26						
	BB454	US26D						
BALL55KIT	Ball Tip Commercial 5" x 5"	US3 US5 US10B	6.55	2	100			
	BB-55	US15						
		US15A						
		US26						
		US26D						
STEEPLE TIP UNIT / EACH								
STP33KIT	Steeple Tip Commercial 3" x 3"	US3 US5 US10B	6.55	2	100			
	TBHSC33 &	US15						
	BBSC33	US15A US26 US26D						
STP35KIT	Steeple Tip Commercial 3 1/2" x 3 1/2"	US3 US5 US10B				6.55	2	100
	TBHSC77,	US15						
	TBHRC66,	US15A						
	BBSC77	US26						
		US26D						
STP44KIT	Steeple Tip Commercial 4" x 4"	US3 US5 US10B	6.55	2	100			
	TBHRC44,	US15						
	TBHSC55,	US15A						
	BBSC56,	US26						
	BBRC45, BBRC5844	US26D						
STP45KIT	Steeple Tip Commercial 4 1/2" x 4 1/2"	US3 US5 US10B	6.55	2	100			
	THB30,	US15						
	TBH454,	US15A						
	BB31,	US26						
	BB454	US26D						

ITEM#	SIZE	FINISH	LIST PRICE	BOX QTY	CASE QTY
DECORATIVE TIPS FOR STEEL PLATED COMMERCIAL HINGES					
STEEPLE TIP UNIT / EACH					
STP55KIT	Steeple Tip Commercial 5" x 5"	US3 US5 US10B	\$6.55	2	100
	BB55	US15			
		US15A			
		US26			
		US26D			
SOLID BRASS HINGES					
Full Mortise, Standard Weight, Plain Bearing UNIT / EACH					
SBTBH30	4 1/2" x 4 1/2"	US3 US26D	51.50 38.00	3	48
Two Ball Bearings, Full Mortise, Standard Weight UNIT / EACH					
SBBB31	4 1/2" x 4 1/2"	US26D US10A US10ANRP US10B US10BNRP US3 US26 US4	54.10 56.50 58.90 56.50 58.90 56.50 56.50 58.50	3	48
Four Ball Bearings, Full Mortise, Heavy Weight UNIT / EACH					
SBBB5200	4 1/2" x 4 1/2"	US10A US10B US10BNRP	91.80 91.80 94.20	3	48
<ul style="list-style-type: none"> Other sizes and finishes available. Price and availability on application. (SUBJECT TO LEAD TIME AND QUANTITY) 					
SPECIALTY HINGES					
CONCEALED BALL BEARING					
Full Mortise, Standard Weight, Concealed Ball Bearing Hinges UNIT / EACH					
BB2255	5" x 5"	US26D US10A US10B US32D	38.60 51.70 51.70 103.70	3	48
BB2200	4 1/2" x 4 1/2"	US26D US4 US10 US10A US10B US15 US3 US26 US26DNRP US32D	17.20 22.10 18.70 18.70 18.70 18.70 22.10 22.10 19.70 61.30	3	48
Full Mortise, Heavy Weight, Concealed Ball Bearing Hinges UNIT / EACH					
BB7755	5" x 5"	US26D US10A US10B US32D	67.60 91.50 91.50 134.50	3	48
BB3300	4 1/2" x 4 1/2"	US26DNRP US10ANRP US10B US3NRP US26NRP US32D US32DNRP	54.30 66.20 66.20 66.20 66.20 109.80 114.70	3	48
<ul style="list-style-type: none"> Other sizes and finishes available up to 5" x 5" upon request. All hinges above are steel base material with the exception of US32D (STAINLESS STEEL). For solid brass base, prefix "SB" before PART # Price and availability on application. (Subject to lead time and quantity) 					

All hinges shown are stock items in US. Designs, sizes and finishes not shown in price list are available subject to quantity and minimum order and lead time.

All hinges are stamped with CRP logo. Finishes in **REVERSE BOLD ITALICS** are also available w/o logo. Prefix "UN" when ordering.

NOTES

- All hinges are sold with a minimum order quantity (MOQ) equal to or exactly divisible by the inner box quantity.
- N.R.P.** (Non-Removable Pin) where not shown **ADD \$2.80 / Each List.**
- N.R.P for US32D ADD \$5.57 / Each List.**

ITEM#	SIZE	FINISH	LIST PRICE	BOX QTY	CASE QTY
SPECIALTY HINGES					
SWING CLEAR HINGES					
Full Mortise, Standard Weight, Two Ball Bearings, Swing Clear UNIT / EACH					
BB350	3 1/2" x 3 1/2"	US15 US26D US3 US10B US26 US4	\$94.90 94.90 119.50 119.50 119.50 87.20	2	50
BB35058	3 1/2" x 3 1/2" 5/8" Radius	US15 US26D US3 US10B US26 US4	94.90 94.90 119.50 119.50 119.50 87.20	2	50
BB400	4" x 4"	US15 US26D US3 US10B US26 US4	97.60 97.60 122.30 122.30 122.30 90.10	2	50
BB40058	4" x 4" 5/8" Radius	US15 US26D US3 US10B US26 US4	97.60 97.60 122.30 122.30 122.30 90.10	2	50
BB600	4 1/2" x 4 1/2"	USP US26D US10A US32DNRP	59.60 59.60 70.60 141.10	3	48
Full Mortise, Heavy Weight, Four Ball Bearings, Swing Clear UNIT / EACH					
BB800	4 1/2" x 4 1/2"	US26D US32D	91.30 174.10	3	48
** 5" Swing Clear, Heavy Weight Ball Bearing 4 1/2", 5". ** 5" Half Mortise, Heavy Weight Ball Bearing Swing Clear. ** 5" Full Surface, Heavy Weight Ball Bearing Swing Clear. ** 5" Half Surface, Heavy Weight Ball Bearing Swing Clear. ***** All of above available for Beveled door upon request. ***** (SUBJECT TO LEAD TIME AND QUANTITY)					

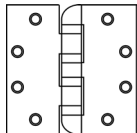
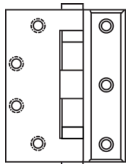
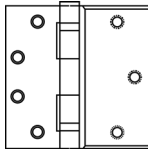
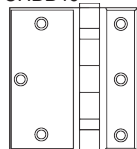
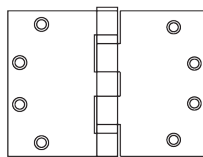
ITEM#	SIZE	FINISH	LIST PRICE	BOX QTY	CASE QTY
SPECIALTY HINGES					
HOSPITAL TIP HINGES					
Full Mortise, Standard Weight, Two Ball Bearings UNIT / EACH					
HOSBB31	4 1/2" x 4 1/2" 0.134" Gauge	US26DNRP US32DNRP	\$33.10 57.40	3	48
Full Mortise, Heavy Weight, Four Ball Bearings UNIT / EACH					
HOSBB5200	4 1/2" x 4 1/2" 0.180" Gauge	US26DNRP US32DNRP	53.00 92.60	3	48
HOSBB5210	5" x 4 1/2" 0.190" Gauge	US26DNRP	90.70	3	48
					
HALF MORTISE					
Half Mortise, Standard Weight, Two Ball Bearings UNIT / EACH					
HMBB4100	4 1/2"	USPNRP US26DNRP US10A	29.50 35.30 44.10	3	36
					
** Half Mortise, Heavy Weight Ball Bearing 4 1/2", 5" available upon request. (Subject to lead time and quantity)					
HALF SURFACE					
Half Surface, Standard Weight, Two Ball Bearings UNIT / EACH					
HSBB4900	4 1/2"	USPNRP US26DNRP US10ANRP	29.50 35.30 44.10	3	36
					
**5" and Half Surface, Heavy Weight Ball Bearing 4 1/2", 5" available upon request. (Subject to lead time and quantity)					
FULL SURFACE					
Full Surface, Standard Weight, Five Knuckle Ball Bearing Hinge With Non-Removable Pin UNIT / EACH					
FSHBB45	4 1/2"	USPNRP	29.50	2	24
					
WIDE THROW HINGES					
Full Mortise, Standard Weight, Two Ball Bearings UNIT / EACH					
WTHBB456	4 1/2" x 6"	US26D US10A US3 US26 US4 US10	58.80 63.70 63.70 63.70 63.70 63.70	3	24
					
**Full Mortise, Standard Weight, Plain Bearing from 3 1/2" x 5" to 5" x 8", available upon request. **Full Mortise, Standard Weight, Two Ball Bearings from 3 1/2" x 5" to 5" x 8", available upon request. **Full Mortise, Heavy Weight, Two Ball Bearings from 4 1/2" x 5" to 5" x 10", available upon request. (SUBJECT TO LEAD TIME AND QUANTITY)					

All hinges are stamped with CRP logo. Finishes in **REVERSE BOLD ITALICS** are also available w/o logo. Prefix "UN" when ordering.

NOTES

- All hinges are sold with a minimum order quantity (MOQ) equal to or exactly divisible by the inner box quantity.
- N.R.P.** (Non-Removable Pin) where not shown **ADD \$2.80 / Each List.**
- N.R.P** for **US32D** **ADD \$5.57 / Each List.**

ITEM#	SIZE	FINISH	LIST PRICE	BOX QTY	CASE QTY
-------	------	--------	------------	---------	----------

ELECTRIFIED HINGES (ENERGY TRANSFER HINGES) STANDARD WEIGHT

Full Mortise, Two Ball Bearings UNIT / EACH

ELE4BB31	4 wires	US26D	\$315.20		
	4 1/2" x 4 1/2"	US3	315.20		
		US10A	315.20		
		US10B	315.20		
		US26	315.20		
		US32D	420.20	1	-
		US10	315.20		
		US15	315.20		
		US4	315.20		
		US5	315.20		

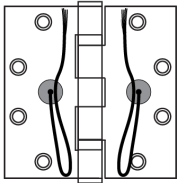

ELE6BB31	6 wires	US10B	358.80		
	4 1/2" x 4 1/2"	US26D	358.80	1	-
		US32D	462.80		

ELE8BB31	8 wires	US10B	411.90		
	4 1/2" x 4 1/2"	US26D	411.90	1	-
		US32D	503.40		

ELQC8BB31	8 wires	US26D	491.90		
	4 1/2" x 4 1/2"	US32D	583.40	1	-

ELQC12BB31	12 wires	US26D	545.90		
	4 1/2" x 4 1/2"	US32D	637.40	1	-

FOR QUICK CONNECT OPTION ON 8-WIRE & 12-WIRE ELECTRIFICATION NOT SHOWN ADD \$94.80 LIST

HEAVY WEIGHT

Full Mortise, Four Ball Bearing UNIT / EACH

ELE4BB5200	4 wires	US10B	400.40		
	4 1/2" x 4 1/2"	US26D	400.40	1	-
		US32D	482.60		
ELE4BB5210	4 wires	US10B	400.40		
	5" x 4 1/2"	US26D	400.40	1	-
		US32D	482.60		

CONCEALED

Standard Weight, Concealed Ball Bearings UNIT / EACH

ELE4BB2200	4 wires	US26D	332.80	1	-
	4 1/2" x 4 1/2"				
ELE8BB2200	8 wires	US26D	420.20	1	-
	4 1/2" x 4 1/2"				

ENERGYTRANSFERHINGESFORPANICBARWITH ELECTRONIC LATCH RETRACTION (ELR) STANDARD WEIGHT

Full Mortise, Two Ball Bearings UNIT / EACH

ELELR4BB31	4 wires	US26D	441.00	1	-
	4 1/2" x 4 1/2"				
ELELR6BB31	6 wires	US26D	441.00	1	-
	4 1/2" x 4 1/2"				
ELELR8BB31	8 wires	US26D	461.80	1	-
	4 1/2" x 4 1/2"				

FOR QUICK CONNECT OPTION ON 8-WIRE AND 12-WIRE ELECTRIFICATION NOT SHOWN ADD \$94.80 LIST

ITEM#	SIZE	FINISH	LIST PRICE	BOX QTY	CASE QTY
-------	------	--------	------------	---------	----------

ENERGYTRANSFERHINGESFORPANICBARWITH ELECTRONIC LATCH RETRACTION (ELR) HEAVY WEIGHT

Full Mortise, Four Ball Bearings

UNIT / EACH

ELELR4BB5200	4 wires	US26D	\$522.10	1	-
	4 1/2" x 4 1/2"				
ELELR6BB5200	6 wires	US26D	522.10	1	-
	4 1/2" x 4 1/2"				
ELELR8BB5200	8 wires	US26D	545.00	1	-
	4 1/2" x 4 1/2"				

Extra Charge On Other Hinges and Wires
CONSULT FACTORY FOR ELECTRIFICATION ON HINGES, FINISHES , MONITOR SWITCH AND 2, 4, 6, 8, 10 or 12 WIRES NOT LISTED ABOVE

All hinges shown are stock items in US. Designs, sizes and finishes not shown in price list are available subject to quantity and minimum order and lead time.

All hinges are stamped with CRP logo. Finishes in **REVERSE BOLD ITALICS** are also available w/o logo. Prefix "UN" when ordering.

NOTES

- All hinges are sold with a minimum order quantity (MOQ) equal to or exactly divisible by the inner box quantity.
- N.R.P.** (Non-Removable Pin) where not shown **ADD \$2.80 / Each List.**
- N.R.P** for **US32D** **ADD \$5.57 / Each List.**

ITEM#	SIZE	FINISH	LIST PRICE	BOX QTY	CASE QTY
-------	------	--------	------------	---------	----------

SPRING HINGES

Full Mortise, Standard Weight, Spring Hinges UNIT / EACH

NEWSH140	4 1/2" x 4 1/2"	USP	19.50		
		US26D	26.80		
		US15	28.20		
		US10A	28.20		
		US10B	28.20		
		US10	24.00	2	48
		US4	24.00		
		US5	28.20		
		US3	31.90		
		US26	31.90		
		US32D	49.00		
		US1	14.10		

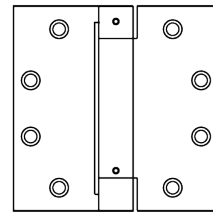

NEWSH454	4 1/2" x 4"	USP	19.50		
		US26D	26.80		
		US10A	28.20		
		US15A	28.20	2	48
		US4	24.00		
		US3	31.90		
		US26	31.90		

BB14031		US26D	69.10	1 SET	16 SETS
		US10B	74.80		
		US4	62.00	(2 pcs	(32 pcs
		US15	73.30	SH140 and	SH140 and
		US26	84.30	1pc BB31)	16 pcs
		USP	49.80		BB31)

2 pcs 4 1/2" X 4 1/2" SH140 SPRING HINGES
1 pc 4 1/2" X 4 1/2" BB31 2-BALL BEARING HINGE
PACKAGED IN ONE INNER BOX AS A SET

All hinges shown are stock items in US. Designs, sizes and finishes not shown in price list are available subject to quantity and minimum order and lead time.

All hinges are stamped with CRP logo. Finishes in **REVERSE BOLD ITALICS** are also available w/o logo. Prefix "UN" when ordering.

NOTES

- All hinges are sold with a minimum order quantity (MOQ) equal to or exactly divisible by the inner box quantity.
- **N.R.P.** (Non-Removable Pin) where not shown **ADD \$2.80 / Each List.**
- **N.R.P** for **US32D** **ADD \$5.57 / Each List.**

ITEM#	SIZE	FINISH	LIST PRICE	BOX QTY	CASE QTY
-------	------	--------	------------	---------	----------

SPRING HINGES

Full mortise, Round Corner, .110" Gauge, Spring Hinge
UNIT / EACH

ITEM#	SIZE	FINISH	LIST PRICE	BOX QTY	CASE QTY
NEWSH44R	4" x 4" 1/4" Radius Template	USP	\$17.20	2	48
		US26D	22.10		
		US10A	23.30		
		US10B	23.30		
		US15A	23.30		
		US15	23.30		
		US4	16.60		
		US3/4	16.60		
		US5	23.30		
		US2D	16.60		
		US3	23.30		
		US26	23.30		
		US1	23.30		
		DURO	17.20		

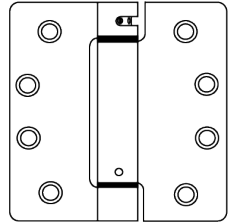

BENCHMARK, ROUND CORNER, .110" GAUGE, SPRING HINGE

UNIT / EACH

ITEM#	SIZE	FINISH	LIST PRICE	BOX QTY	CASE QTY
NBENSH4458R	4" x 4" 5/8" Radius	US4	15.00	2	48
		US26D	18.20		

Benchmark Spring hinge screws specification:
4 pcs wood screws #10 x 1"
4 pcs machine screws
1/2 x 12-24 per hinge

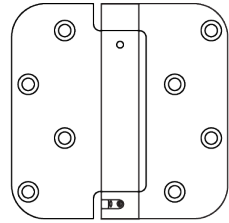

CASTLEGATE COMBINATION CORNER SPRING HINGE

UNIT / EACH

ITEM#	FINISH	LIST PRICE	BOX QTY	CASE QTY
CSH4458RSRLH CSH4458RSRRH	US26D	22.10	2	48
	US2D	16.60		
	US15	16.20		

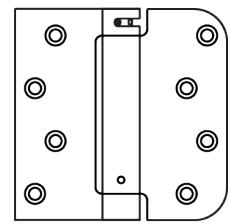

Handed, combination square and round corner 5/8" spring hinge
LH (Left Hand)
RH (Right Hand)
8 pcs wood screws 1" x 10
4 pcs machine screws #10 head
1/2" x 12-24 per hinge

ITEM#	SIZE	FINISH	LIST PRICE	BOX QTY	CASE QTY				
SPRING HINGES									
UNIT / EACH									
NEWSH4458R	4" X 4" 5/8" Radius Non-Template	USP	\$16.60	2	48				
		US26D	22.10						
		US4	16.60						
		US3/4	16.60						
		US2D	16.60						
		US3	23.30						
		US5	23.30						
		US26	23.30						
		US10B	23.30						
		US15A	23.30						
		US15	23.30						
		US1	23.30						
		BUSH-4458R	4" X 4" 5/8" Radius Non-Template			US26D	22.10	---	48
						US15	23.30		
US2D	16.60								
NEWSH35R	3 1/2" X 3 1/2" 1/4" Radius Template	USP	15.20	2	48				
		US26D	20.90						
		US10A	22.10						
		US10B	22.10						
		US15	22.10						
		US15A	22.10						
		US2D	15.20						
		US4	15.20						
		US3	22.10						
		US26	22.10						
US1	22.10								
NEWSH3558R	3 1/2" X 3 1/2" 5/8" Radius Template	US4	15.20	2	48				
		US2D	15.20						
		US3	22.10						
		US26	22.10						
		US26D	15.20						
		US10B	22.10						
		US15	22.10						
		US15A	22.10						
		US1	22.10						
		NEWSCSH35	3 1/2" X 3 1/2" Square Corner Template			US4	15.20	2	48
US26D	20.90								
US26	22.10								
** Other finishes available upon request									
EXTRUDED SOLID BRASS HINGES									
Full Mortise, Two Ball Bearings									
LIFE TIME FINISH			UNIT / EACH						
LIFSBBH45	4 1/2" X 4 1/2"	US3	48.40	2	60				
LIFSBBH44	4" X 4"	US3	41.60	2	60				
LIFSBBH35	3 1/2" X 3 1/2"	US3	35.90	2	60				
STANDARD FINISH			UNIT / EACH						
SBBH45	4 1/2" X 4 1/2" .134" Gauge	US3	46.30	2	60				
		US5	46.30						
		US26	46.30						
		US10B	46.30						
		US15	46.30						
		US15A	46.30						
		US26D	46.30						

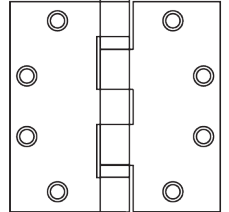

All hinges shown are stock items in US. Designs, sizes and finishes not shown in price list are available subject to quantity and minimum order and lead time.

All hinges are stamped with CRP logo. Finishes in **REVERSE BOLD ITALICS** are also available w/o logo. Prefix "UN" when ordering.

NOTES

- All hinges are sold with a minimum order quantity (MOQ) equal to or exactly divisible by the inner box quantity.
- **N.R.P.** (Non-Removable Pin) where not shown **ADD \$2.80 / Each List.**
- **N.R.P** for **US32D** **ADD \$5.57 / Each List.**

ITEM#	SIZE	FINISH	LIST PRICE	BOX QTY	CASE QTY
-------	------	--------	------------	---------	----------

EXTRUDED SOLID BRASS HINGES

Full Mortise, Two Ball Bearings

STANDARD FINISH UNIT / EACH

SBBH44	4" X 4" .130" Gauge	US3	\$41.60		
		US5	41.60		
		US26	41.60		
		US10B	41.60	2	60
		US15	41.60		
		US15A	41.60		
		US26D	41.60		

SBBH35	3 1/2" X 3 1/2" .123" Gauge	US3	35.90		
		US5	35.90		
		US26	35.90		
		US10B	35.90	2	60
		US15	35.90		
		US15A	35.90		
		US26D	35.90		

Full Mortise, Plain Bearing UNIT / EACH

SBH45	4 1/2" X 4 1/2" .134" Gauge	US3	44.20	2	60
SBH44	4" X 4" .130" Gauge	US3	39.60	2	60
SBH35	3 1/2" X 3 1/2" .123" Gauge	US3	37.50	2	60

DECORATIVE TIPS FOR EXTRUDED SOLID BRASS HINGES
LIFE TIME FINISH UNIT EACH PER HINGE

LIFST	Steeple Tip	US3			
LIFAC	Acorn Tip	US3	5.44	1	---
LIFBL	Ball Tip	US3			
LIFUR	Urn Tip	US3			

STANDARD FINISH UNIT EACH PER HINGE

BL		Ball Tip	US3			
			US5			
			US26			
			US10B	4.44	1	---
			US15			
			US15A			
		US26D				

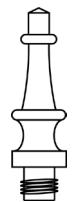
ST		Steeple Tip	US3			
			US5			
			US26			
			US10B	4.44	1	---
			US15			
			US15A			
		US26D				

AC		Acorn Tip	US3			
			US5			
			US26			
			US10B	4.44	1	---
			US15			
			US15A			
		US26D				

ITEM#	SIZE	FINISH	LIST PRICE	BOX QTY	CASE QTY
-------	------	--------	------------	---------	----------

DECORATIVE TIPS FOR EXTRUDED SOLID BRASS HINGES
STANDARD FINISH UNIT EACH PER HINGE

UR		Urn Tip	US3			
			US5			
			US26			
			US10B	4.44	1	---
			US15			
			US15A			
				US26D		

*Tips fit all sizes. Prefix tip design to item number.

TIMELY, REDDI FRAME HINGES

Round Corner, Full Mortise, Plain Bearing - Template Residential Weight, 1/2 MS - 1/2 WS UNIT / EACH

TBHRC33	4" X 4" 1/4" Radius	US26D	7.40		
		US26DNRP	8.40		
		US10A	7.40		
		US10B	7.40		
		US10BNRP	9.90		
		US4	7.40	3	48
		US3	8.40		
		US26	8.40		
		US28	5.40		
		DURO	5.40		
		US1DBLK	5.40		

TBHRC45	3 1/2" X 3 1/2" 1/4" Radius	US26D	6.50				
		US10A	6.50				
		US10B	6.50				
		US4	5.10				
		US3	8.40	2	100		
		US26	8.40				
		US28	4.00				
		DURO	4.00				
				US1BLK	4.00		

RESIDENTIAL HINGES

BBRH40	BBRH60	BBRH61	BBRH35
--------	--------	--------	--------

Full Mortise, Residential Weight, 2-Ball Bearings, 2 each / Inner Box w/ flycut wood screws, Round Corner, 5 Knuckles UNIT / EACH

BBRH60	4" X 4" 1/4" Radius	US3	6.80		
		US4	5.20		
		US10B	6.50		
		US11P	6.50	2	100
		US15	6.10		
		US26	6.80		
		US26D	6.10		
		US26DNRP	6.50		

BBRH61	3 1/2" X 3 1/2" 1/4" Radius	US3	6.10		
		US4	4.10		
		US10B	5.80		
		US11P	5.80	2	100
		US15	5.30		
		US26	6.10		
		US26D	5.30		

All hinges shown are stock items in US. Designs, sizes and finishes not shown in price list are available subject to quantity and minimum order and lead time.

All hinges are stamped with CRP logo. Finishes in **REVERSE BOLD ITALICS** are also available w/o logo. Prefix "UN" when ordering.

NOTES
 • All hinges are sold with a minimum order quantity (MOQ) equal to or exactly divisible by the inner box quantity.
 • **N.R.P.** (Non-Removable Pin) where not shown **ADD \$2.80 / Each List.**
 • **N.R.P.** for **US32D ADD \$5.57 / Each List.**

ITEM#	SIZE	FINISH	LIST PRICE	BOX QTY	CASE QTY
-------	------	--------	------------	---------	----------

RESIDENTIAL HINGES

Full Mortise, Residential Weight, 2-Ball Bearings, 2 each / Inner Box w/ flycut wood screws, Round Corner, 5 Knuckles

UNIT / EACH					
BBRH40	4" X 4"	US3	\$6.80	2	100
		5/8" Radius	US4		
		US10B	6.50		
		US11P	6.50		
		US15	6.10		
		US26	6.80		
		US26D	6.10		
		US26DNRP	6.50		

BBRH35	3 1/2" X 3 1/2"	US3	6.10	2	100
		5/8" Radius	US4		
		US10B	5.80		
		US11P	5.80		
		US15	5.30		
		US26	6.10		
	US26D	5.30			

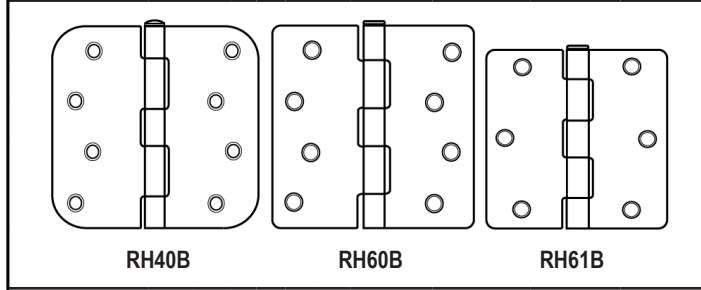

Full Mortise, Residential Weight, Plain Bearing, Bulk Assembled w/ flycut wood screws Round Corner, 5 Knuckles

UNIT / EACH					
RH40B	4" X 4"	US4	3.60	---	100
		5/8" Radius	US4NRP		
		US3/4	3.60		
		US2D	3.50		
		US26D	4.70		
RH60B	4" X 4"	US4	3.60	---	100
		1/4" Radius	US4NRP		
		US3/4	3.60		
		US2D	3.50		

ITEM#	SIZE	FINISH	LIST PRICE	BOX QTY	CASE QTY
-------	------	--------	------------	---------	----------

RESIDENTIAL HINGES

Full Mortise, Residential Weight, Plain Bearing, Bulk Assembled w/ flycut wood screws Round Corner, 5 Knuckles

UNIT / EACH					
RH35B	3 1/2" X 3 1/2"	US4	\$2.80	---	100
		5/8" Radius	US3/4		
		US2D	2.70		
		US3	4.70		
		US26D	4.00		
		US15A	4.40		
		US15	4.00		
		US26	4.70		
		US5	4.40		
		US10B	4.40		
		US11P	4.40		

RH61B	3 1/2" X 3 1/2"	US4	2.80	---	100
		1/4" Radius	US 3/4		
		US2D	2.70		

****Other finishes are available bulk upon request. (Subject to lead time)**

Full Mortise, Residential Weight Plain Bearing, Bulk Unassembled w/ flycut wood screws Round Corner, 5 Knuckles

UNIT / EACH					
UARH40B	4" X 4"	US4	3.60	---	100
		5/8" Radius	US2D		
UARH60B	4" X 4"	US4	3.60	---	100
		1/4" Radius	US2D		

Full Mortise, Residential Weight Plain Bearing, 2 Each / Inner Box w/ flycut wood screws, Round Corner, 5 Knuckles

UNIT / EACH					
RH40	4" X 4"	US2D	3.80	2	100
		5/8" Radius	US3		
	Non Template	US3NRP	6.10		
		US26D	4.90		
		US15A	5.40		
		US15	4.90		
		US15NRP	7.40		
		US26	5.60		
		US26DNRP	7.40		
		US5	5.40		
		US10	5.40		
		US10B	5.40		
		US10BNRP	7.80		
		US11P	5.40		
		US11PNRP	7.80		
	US32D	14.80			
	US32DNRP	15.80			
	US1	6.30			

RH91	4" X 4"	US4	4.00	2	100
	Square Corner				

RH90	3 1/2" X 3 1/2"	US4	4.00	2	100
	Square Corner				

RH33	3 1/2" X 3 1/2"	US4	4.00	2	100
	Square Corner				

All hinges shown are stock items in US. Designs, sizes and finishes not shown in price list are available subject to quantity and minimum order and lead time.

All hinges are stamped with CRP logo. Finishes in **REVERSE BOLD ITALICS** are also available w/o logo. Prefix "UN" when ordering.

NOTES
 • All hinges are sold with a minimum order quantity (MOQ) equal to or exactly divisible by the inner box quantity.
 • **N.R.P.** (Non-Removable Pin) where not shown **ADD \$2.80 / Each List.**
 • **N.R.P.** for **US32D ADD \$5.57 / Each List.**

ITEM#	SIZE	FINISH	LIST PRICE	BOX QTY	CASE QTY
-------	------	--------	------------	---------	----------

RESIDENTIAL HINGES

Full Mortise, Residential Weight
 Plain Bearing, 2 Each / Inner Box w/ flycut wood screws,
 Round Corner, 5 Knuckles

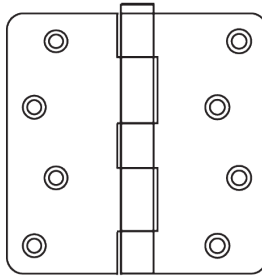
UNIT / EACH					
	RH60	4" X 4"	US4	\$4.00	
		1/4" Radius	US4NRP	4.40	
		Non Template	US3	5.60	
			US3NRP	6.10	
			US26D	4.90	
			US26DNRP	5.40	
			US15A	5.40	
			US15	4.90	
			US15NRP	7.40	
			US26	5.60	
			US26NRP	8.00	
			US5	5.40	2
			US10	5.40	100
			US10B	5.40	
			US10BNRP	7.80	
			US11P	5.40	
			US11PNRP	7.80	
			US32D	14.80	
			US32DNRP	15.80	
			US1	6.30	
		USP	4.00		
		USPNRP	6.40		
		US10A	5.40		

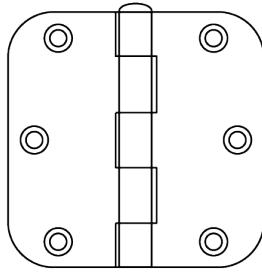
	RH35	3 1/2" X 3 1/2"	US4	3.00	
		5/8" Radius	US3	4.90	
		Template	US26D	4.20	
			US15A	4.70	
			US15	4.20	
			US26	4.90	
			US5	4.70	2
			US10	4.70	100
			US10B	4.70	
			US11P	4.70	
		US32D	12.90		
		US1	5.70		
		US10A	4.70		

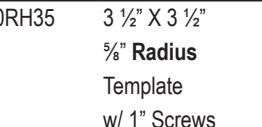
	10RH35	3 1/2" X 3 1/2"	US26D	4.40	
		5/8" Radius	US15	4.40	
		Template	US26	5.10	2
		w/ 1" Screws	US10B	4.90	100

ITEM#	SIZE	FINISH	LIST PRICE	BOX QTY	CASE QTY
-------	------	--------	------------	---------	----------

RESIDENTIAL HINGES

Full Mortise, Residential Weight
 Plain Bearing, 2 Each / Inner Box w/ flycut wood screws,
 Round Corner, 5 Knuckles

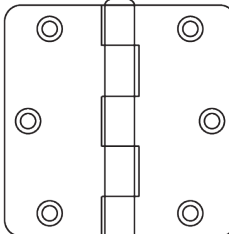
UNIT / EACH					
	RH61	3 1/2" X 3 1/2"	US4	\$3.00	
		1/4" Radius	US4NRP	3.20	
		Template	US3	4.90	
			US26D	4.20	
			US15A	4.70	
			US15	4.20	
			US26	4.90	2
			US5	2.70	100
			US10B	2.70	
			US11P	2.70	
		US32D	12.90		
		US1	5.70		
		US10	6.30		

CASTLEGATE COMBINATION CORNER HINGES

UNIT / EACH

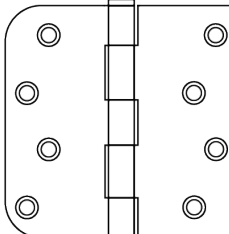
	CAS44R (Right Hand)	US26D	5.10	
	CAS44L (Left Hand)	US26DNRP	7.60	2
		US2D	4.70	100
		US2DNRP	7.10	
			Handed combination square and round corner 5/8" hinge LH (Left Hand) RH (Right Hand) 8 pcs wood screws 1" x 10 4 pcs machine screws #10 head 1/2" x 12-24 per hinge	

RESIDENTIAL HINGES

Full Mortise, Residential Weight,
 Plain Bearing, Bulk Unassembled w/ flycut wood screws
 Round Corner, 6 Knuckles

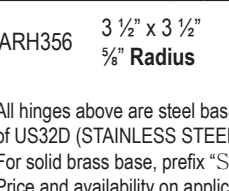
UNIT / EACH					
	UARH356	3 1/2" x 3 1/2"	US4	2.60	---
		5/8" Radius			100
<ul style="list-style-type: none"> • All hinges above are steel base material with the exception of US32D (STAINLESS STEEL). • For solid brass base, prefix "SB" before PART # • Price and availability on application. (Subject to lead time and quantity) 					

Benchmark, Hole Pattern, Residential Weight,
 Bulk Assembled, with screws

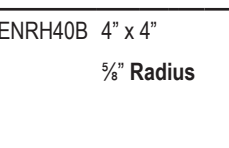
UNIT / EACH					
	BENRH40B	4" x 4"	US26DNRP	7.40	
		5/8" Radius	US4	3.00	---
			USP	3.00	100
			USPNRP	4.20	

Benchmark residential weight screw specification
 3 pcs wood screws #10 x 3/4", 1pc wood screw #10 x 2"
 4 pcs machine screws 1/2" x 10-24 per hinge.
 ▶ Benchmark spring hinges available. See spring hinge section

All hinges shown are stock items in US. Designs, sizes and finishes not shown in price list are available subject to quantity and minimum order and lead time.

All hinges are stamped with CRP logo. Finishes in **REVERSE BOLD ITALICS** are also available w/o logo. Prefix "UN" when ordering.

NOTES

- All hinges are sold with a minimum order quantity (MOQ) equal to or exactly divisible by the inner box quantity.
- **N.R.P.** (Non-Removable Pin) where not shown **ADD \$2.80 / Each List.**
- **N.R.P.** for **US32D** **ADD \$5.57 / Each List.**

ITEM#	SIZE	FINISH	LIST PRICE	BOX QTY	CASE QTY
-------	------	--------	------------	---------	----------

RESIDENTIAL SQUARE CORNER STAINLESS STEEL HINGES

Full Mortise, Residential Weight, Template hole pattern, Plain Bearing, 2 Each / Inner Box with wood screws, Square Corner, 0.080" Gauge

UNIT / EACH					
LTBHSC55	4" X 4" Square Corner	US32D	\$14.80	2	100
LTBHSC77	3 1/2" x 3 1/2" Square Corner	US32D	12.90	2	100
LTBHSC33	3" x 3" Square Corner	US32D	10.90	2	100

DECORATIVE TIPS FOR STEEL PLATED RESIDENTIAL HINGES

BALL TIP UNIT / EACH

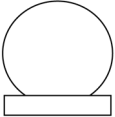
UNIT / EACH						
	RESBLTP35KIT	Ball Tip	US3	PRICE INCLUDES: 1 PIN & 2 TIPS		
		Residential	US5			
		3 1/2" x 3 1/2"	US10B	6.55	2	100
		Hinge for	US15			
		RH35,	US15A			
		RH35B,	US26			
	RH61,	US26D				
	RH61B					

UNIT / EACH						
	RESBLTP44KIT	Ball Tip	US3	PRICE INCLUDES: 1 PIN & 2 TIPS		
		Residential	US5			
		4" x 4" hinge	US10B	6.55	2	100
		RH60,	US15			
		RH40,	US15A			
		RH60B,	US26			
	RH40B	US26D				

STEEPLE TIP UNIT / EACH

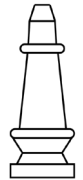
UNIT / EACH						
	RESSTP35KIT	Steeple Tip	US3	PRICE INCLUDES: 1 PIN & 2 TIPS		
		Residential	US5			
		3 1/2" x 3 1/2"	US10B	6.55	2	100
		Hinge for	US15			
		RH35,	US15A			
		RH61	US26			
	RH35B,	US26D				
	RH61B					

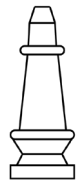
UNIT / EACH						
	RESSTP44KIT	Steeple Tip	US3	PRICE INCLUDES: 1 PIN & 2 TIPS		
		Residential	US5			
		4" x 4" Hinge	US10B	6.55	2	100
		for RH60,	US15			
		RH40,	US15A			
		RH60B,	US26			
	RH40B					

ITEM#	SIZE	FINISH	LIST PRICE	BOX QTY	CASE QTY
-------	------	--------	------------	---------	----------

SOLID BRASS PARLIAMENT HINGES

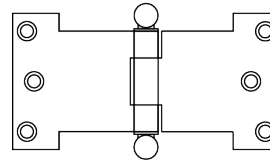

► **PACKAGING INCLUDES**

- ◆ One pair per inner box, individually poly bagged.
- ◆ 100 pcs / Master carton

Packed with #9 x 3/4" wood screws. Ball tip attached

UNIT / EACH

PARH3A	3" x 2 1/4" x 0.093"	US3	\$24.30	2	100
		US15			
		US10B			
		US15A			
		US26			
		US5			

PARH4B	4" x 2 1/2" x 0.093"	US3	26.50	2	100
		US15			
		US10B			
		US15A			
		US26			
		US5			

PARH458C	4 5/8" x 2 1/2" x 0.093"	US3	28.70	2	100
		US15			
		US10B			
		US15A			
		US26			
		US5			

REINFORCING PIVOT HINGES

Full Surface Reinforcing Pivot Hinge for 4 1/2" Wide Hinges

UNIT / EACH

RPH45	4 1/2" wide	US26D	145.60	1	10
-------	-------------	-------	--------	---	----

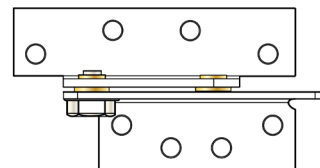

RPH45SHIM	1/8" Shim plate for PH45	USP	13.90	1	1
-----------	--------------------------	-----	-------	---	---

CABINET HINGES

UNIT / EACH

CABH-2015	2" x 1 1/2"	US10B	16.30	10	100
		US15	15.40	10	100

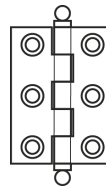

CABH-2517	2 1/2" x 1 11/16"	US10B	18.80	10	100
		US15	17.60	10	100

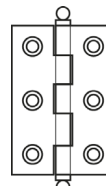

HINGE SCREWS *List Price . . .*

STEEL SCREWS FOR TBHRC33 AND TBHRC45, 4" X 4" AND 3 1/2" X 3 1/2" TIMELY HINGES, 4" X 4" and 3 1/2" X 3 1/2" SPRING HINGES, 3 1/2" X 3 1/2" Contract Grade Hinges

STEEL SCREWS FOR CONTRACT GRADE SIZE 4" , 4.5" AND 5"

ITEM#	SIZE	FINISH	LIST PRICE	BOX QTY
-------	------	--------	------------	---------

MACHINE 1/2" x 12-24 FPHM				
MSC1224		USP		
		US26D		
		US10A		
		US10B		
		US10	\$32.75	100
		US4		
		US3		
		US26		
		DURO		
		US32D	65.27	100

WOOD 1 1/4" x 12 FPHW				
WSC11412		USP		
		US26D		
		US10A		
		US10B		
		US10	32.75	100
		US4		
		US3		
		US26		
		DURO		
		US32D	65.27	100

WOOD 1" x 12 FPHW				
WSC11299		USP		
		US26D		
		US10A		
		US10B		
		US10	32.75	100
		US4		
		US3		
		US26		
		US15		
		DURO		

STEEL SCREWS FOR RESIDENTIAL HINGES (4" x 4" and 3 1/2" x 3 1/2")

ITEM#	SIZE	FINISH	LIST PRICE	BOX QTY
-------	------	--------	------------	---------

WOOD 1" x 9 with flycut (4" x 4" size hinge)				
TWSC19		US26D		
		US10A		
		US4	32.75	100
		US3		
		US26		

WOOD 3/4" x 9 with flycut (3 1/2" x 3 1/2" size hinge)				
RESWC349		US26D		
		US10A		
		US4	32.75	100
		US3		
		US26		

ITEM#	SIZE	FINISH	LIST PRICE	BOX QTY
-------	------	--------	------------	---------

Machine 1/2" x 12 - 24 with #10 head FPHM (4" X 4" SIZE HINGE, 1/4" radius)

TMC1224		USP		
		US26D		
		US10A		
		US4		
		US3	\$32.75	100
		US26		
		US28		
		US15		
		US10B		
		DURO		

Machine 1/2" x 10 - 24 with #10 head FPHM (4" x 4" size hinge, 5/8" radius) for SH4458R

TMC10244458R		USP		
		US26D		
		US10A		
		US4	32.75	100
		US3		
		US26		
		US10B		
		DURO		

Wood 1" x 10 FPHW (4" x 4" size hinge)

TWSC110		USP		
		US26D		
		US10A		
		US4		
		US3	32.75	100
		US26		
		US10B		
		US15		
		US15A		
		DURO		

Machine 1/2" x 10 - 24 #9 Head FPHM (3 1/2" x 3 1/2" size hinge)

TMC121024		USP		
		US26D		
		US10A		
		US4		
		US3	32.75	100
		US26		
		US10B		
		US32D		
		DURO		





Wood 1" x 9 FPHW (3 1/2" x 3 1/2" size hinge)

TWSC19		USP		
		US26D		
		US10A		
		US4		
		US3		
		US26	32.75	100
		US28		
		US10B		
		US15		
		US15A		
		DURO		

GEARED ALUMINUM CONTINUOUS HINGES

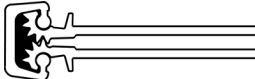
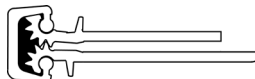
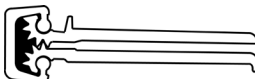
Series List Price

► Heavy Duty

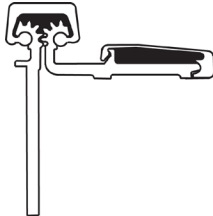
ITEM#	DESCRIPTION	SIZE	FINISH	LIST PRICE	CASE QTY	UNIT
CONCEALED LEAF						
	CRHD781120	83"	CLEAR	\$285.00	1	Ea.
			DB	295.40		
		95"	CLEAR	326.60		
			DB	341.20		
	CRHD781110	83"	CLEAR	295.40		
			DB	307.90		
		95"	CLEAR	339.10		
			DB	351.60		
	CRHD782240 (1 3/4" doors)	83"	CLEAR	307.90		
			DB	318.30		
		95"	CLEAR	353.60		
			DB	366.10		
FULL SURFACE						
	CRHD781570	83"	CLEAR	328.70	1	Ea.
			DB	341.20		
		95"	CLEAR	380.70		
			DB	391.10		
	CRHD782100	83"	CLEAR	341.20		
			DB	353.60		
		95"	CLEAR	391.10		
			DB	405.60		
	CRHD780570	83"	CLEAR	374.40		
			DB	386.90		
		95"	CLEAR	430.60		
			DB	443.10		
HALF SURFACE						
	CRHD780530	83"	CLEAR	364.00	1	Ea.
			DB	376.50		
		95"	CLEAR	416.00		
			DB	430.60		
**SPECIFY SIZE AND FINISH AFTER ITEM#						
<ul style="list-style-type: none"> • For additional fire rating Prefix "UL" before part# • Add \$90.06 List • Refer to fire rating chart for standard fire rating 						

► **Electrification**

◆◆ DOES NOT INCLUDE HINGE COST ◆◆			
CODE	NO. OF WIRES	CONTINUOUS HINGE ELECTRIFICATION MODIFICATIONS FOR CRHD781120 AND CRHD782240 ONLY	LIST PRICE
CET8	8	Removable 12" Aluminum Gear Hinge. Can easily be removed for adjustment and service.	\$1119.77
EPT	--	Cut-out according to Von Duprin Part # EPT-10 and Cal-Royal CRPT-10, CRPT-10C and CRPT-2 location	184.70

TO ELECTRIFY: Prefix **CODE** before **PART#**. For Example: To order 8-wire on 1 piece of CRHD781120 ALUM Gear hinge with a length of 83", use "**CET8CRHD78112083 CLEAR**"

► **Additional Heavy Duty Channel Cover**

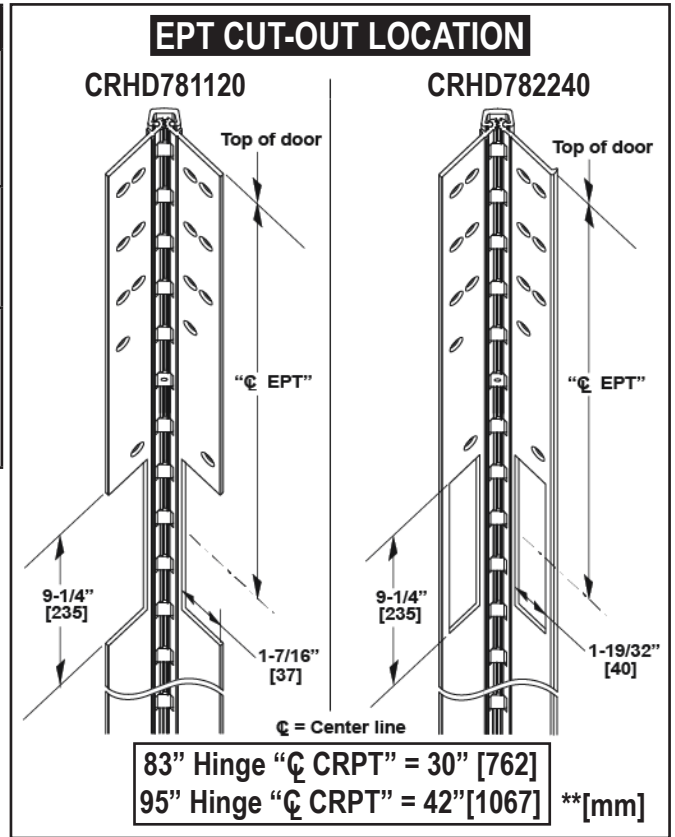
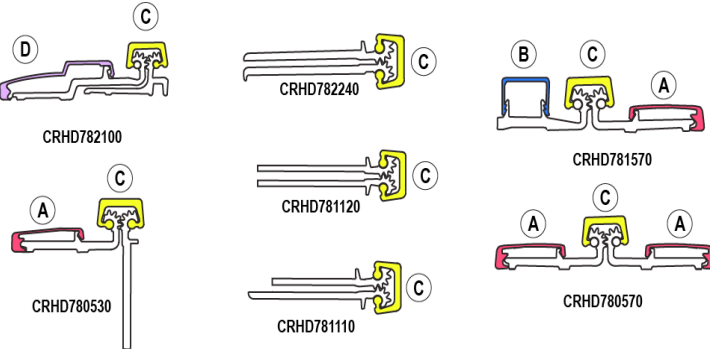

◆◆FOR OTHER LOCATIONS CONSULT FACTORY◆◆

ITEM#	DESCRIPTION	SIZE	FINISH	LIST PRICE	CASE QTY	UNIT
CC83A	Channel Cover (A). Can be used for CRHD781570, CRHD780570 and CRHD780590	83"	Clear	\$43.70	Ea.	1
CC95A			Dark Bronze	43.70		
CC83B	Channel Cover (B) Can be used for CRHD781570	83"	Clear	37.50		
			Dark Bronze	39.60		
CC95B		95"	Clear	41.60		
			Dark Bronze	43.70		
CC83C	Common Channel Gear Cover (C) Can be used for all models of continuous geared hinges	83"	Clear	60.40		
			Dark Bronze	62.40		
CC95C		95"	Clear	66.60		
			Dark Bronze	70.80		
CC83D	Channel Cover (D) Can be used for CRHD782100	83"	Clear	64.50		
			Dark Bronze	66.60		
CC95D		95"	Clear	72.80		
			Dark Bronze	74.90		

CONTINUOUS HINGE MODEL CROSS REFERENCE

CAL-ROYAL	ROTON	PEMKO	MARKAR	MCKINNEY	ZERO	STANLEY	ABH	SELECT
CRHD781120	780-112HD	FMSLFHD	FM2000	MCK12HD	910DB	661HD	A110HD	SL11HD
CRHD782240	780-224HD	FMHD	FM2011	MCK25HD	914DB	662HD	A240HD	SL24HD
CRHD781570	780-157HD	FSCPHD		MCK58HD	935DB	664HD	A570HD	SL57HD
CRHD782100	780-210HD	FSHD	FM2009	MCK22HD	930DB		A210HD	SL18HD
CRHD781110	780-111HD	FMSLIHD		MCK-14HD			A111HD	SL18HD
CRHD780530	780-053HD				925DB		A530HD	SL53HD
CRHD780570	780-057HD		FS2002				A571HD	SL60HD